



**NATIONAL COMMISSION FOR THE
CERTIFICATION OF CRANE OPERATORS (NCCCO)**

**RIGGER REFERENCE
MANUAL**

HOLD HARMLESS/RELEASE/DISCLAIMER AGREEMENT

The reading and/or using person or entities using this publication for and in consideration of the assistance, cooperation, and information given by the National Commission for the Certification of Crane Operators (NCCCO) in this publication, *Rigger Reference Manual*, the receipt of which is acknowledged, does hereby and for all future time have released, hold harmless from any liability, and forever discharged for itself, its administrators and assigns the said NCCCO from all and any manner of action or demands whatsoever in law, in admiralty, or in equity, which against the said NCCCO anyone ever had, now have, or which shall be later claimed. This agreement relates specifically to any cause of action arising out of the publication, information provided, subsequent conduct, and any use of the information provided in this publication

and related uses or demonstrations of skills, methods, and techniques cite in the publication. This mutually beneficial release and hold harmless agreement may not be changed orally, and exists in perpetuity. NCCCO generally and specifically disclaims any warranty, merchantability of intended or unintended use or liability lifting industry and promote public safety.

Copyright 2009–2019 by National Commission for the Certification of Crane Operators. All rights reserved. No part of this book may be reproduced or transmitted in any form or by any means, electronic or mechanical, including photocopying, without prior written permission from the publisher. For information, contact the publisher, National Commission for the Certification of Crane Operators, Inc.



Preface

This manual has been provided as a reference source for candidates preparing to take the NCCCO Rigger certification exams. NCCCO subject matter experts compiled from a number of sources and selected sections of relevant material for inclusion in the *NCCCO Rigger Reference Manual*. ASME and OSHA granted NCCCO permission for posting and printing selected sections from the following ASME and OSHA standards:

- ASME B30.5 - Mobile and Locomotive Cranes
- ASME B30.10 - Hooks
- ASME B30.20 - Below-the-Hook Lifting Devices
- OSHA 1910.184 - Slings
- OSHA 1926.251 - Rigging Equipment for Material Handling
- OSHA 29 CFR 1926 Subpart CC - Cranes and Derricks in Construction

Portions reprinted from ASME B30.5, B30.10, and ASME B30.20 by permission of The American Society of Mechanical Engineers. All rights reserved.

The following reference materials, in addition to the references cited above, are used by NCCCO's Examination Committee to verify the accuracy of NCCCO test questions.

- ASME B30.9 - Slings
- ASME B30.26 - Rigging Hardware
- *IPT's Crane and Rigging Training Manual*
- *Rigging for Ironworkers Reference Manual*
- *NCCCO Rigger Reference Booklet*

The material contained herein is not to be used for any other purpose than reference material in association with preparing for the NCCCO exam. No part of this manual is to be copied or used in any manner other than by individual candidates preparing for the NCCCO Rigger examination.

This page intentionally left blank



Table of Contents

Chapter 1: ASME B30.5-2018 – Mobile and Locomotive Cranes	1
Section 5-3.1.3: Responsibilities	
5-3.1.3.2: Responsibilities of Site Supervisor and Lift Director	3
5-3.1.3.2.1 Site Supervisor	3
5-3.1.3.2.2 Lift Director	4
5-3.1.3.4: Responsibilities of the Rigger	4
Chapter 2: ASME B30.10-2014 – Hooks	5
Section 10-1: Selection, Use, and Maintenance	7
10-1.8: Identification	7
10-1.10.6 Repairs and Modifications	7
10-1.11: Operating Practices	7
10-1.11.1 Single Point Hooks	7
10-1.11.2 Duplex and Quad Hooks	8
Chapter 3: ASME B30.20-2018 – Below the Hook Lifting Devices	9
Section 20-1.2: Marking, Construction, and Installation	11
20-1.2.1: Marking	11
(a) Rated Load	11
(b) Identification	11
Section 20-1.3 Inspection, Testing, and Maintenance	11
20-1.3.2: Every Lift Inspection	11
20-1.3.3: Frequent Inspection	11
Section 20-1.4: Operation	11
20-1.4.1 Operators	11
20-1.4.2 Qualifications	11
20-1.4.3 Responsibilities	12
20-1.4.3.1 Responsibilities of the Lifting Device Owner	12
20-1.4.3.2 Responsibilities of Operators	12
20-1.4.4 Lifting Device Operating Practices	13
20-1.4.5 Miscellaneous Operating Practices	13
Section 20-1.5 Instruction Manuals	13
Chapter 4: OSHA 1910.184 – Slings	15
Regulations 1910.184	17
§ 1910.184 Slings	17
Chapter 5: OSHA 1926.251 – Rigging Equipment for Material Handling	27
Regulations 1926.251	29
§ 1926.251 Rigging Equipment for Material Handling	29

Chapter 6: OSHA 29 CFR 1926, Subpart CC – Cranes and Derricks in Construction..	33
Regulations 1926 Subpart CC	35
§ 1926.1401 Definitions	35
§ 1926.1404 Assembly/Disassembly—general requirements (applies to all assembly and disassembly operations)	39
§ 1926.1405 Disassembly—additional requirements for dismantling of booms and jibs (applies to both the use of manufacturer procedures and employer procedures)	41
§ 1926.1406 Assembly/Disassembly—employer procedures—general requirements	42
§ 1926.1407 Power line safety (up to 350 kV)—assembly and disassembly.	42
§ 1926.1408 Power line safety (up to 350 kV)—equipment operations	43
§ 1926.1409 Power line safety (over 350 kV)	45
§ 1926.1410 Power line safety (all voltages)—equipment operations closer than the Table A zone	45
§ 1926.1411 Power line safety—while traveling under or near power lines with no load	47
§ 1926.1424 Work area control	47
§ 1926.1425 Keeping clear of the load	48
§ 1926.1431 Hoisting personnel	48
§ 1926.1432 Multiple-crane/derrick lifts— supplemental requirements	54
Appendix A to Subpart CC of Part 1926—Standard Hand Signals	55
Chapter 7: Rigger Reference Booklet	57



CHAPTER 1:
**ASME B30.5-2018 – Mobile and
Locomotive Cranes**

**Section 5-3.1.3.2: Responsibilities
of Site Supervisor and Lift Director**

Reprinted from ASME B30.5, by permission of the American Society of Mechanical Engineers. All rights reserved.

This page intentionally left blank



Section 5-3.1.3.2: Responsibilities of Site Supervisor and Lift Director

ASME B30.5 applies to CCO Rigger Level II Exam only.

5-3.1.3 Responsibilities

While the organizational structure of various projects may differ, the following roles are described here for purposes of delineating responsibilities. All responsibilities listed below shall be assigned in the worksite organization. (A single individual may perform one or more of these roles.)

- (a) *Crane Owner.* The crane owner has custodial control of a crane by virtue of lease or ownership.
- (b) *Crane User.* The crane user arranges the crane's presence on a worksite and controls its use there.
- (c) *Site Supervisor.* The site supervisor exercises supervisory control over the worksite on which a crane is being used and over the work that is being performed on that site.
- (d) *Lift Director.* The lift director directly oversees the work being performed by a crane and the associated rigging crew.
- (e) *Crane Operator.* The crane operator directly controls the crane's functions.
- (f) *Rigger.* The rigger selects, configures, and assembles the rigging equipment for attachment, support, control, and detachment of the load during lifting activities.

5-3.1.3.2 Responsibilities of Site Supervisor and Lift Director

In some situations the site supervisor and the lift director may be the same person.

5-3.1.3.2.1 Site Supervisor

The site supervisor's responsibilities shall include the following:

- (a) ensuring that the crane meets the requirements of Chapter 5-2 prior to initial site usage.
- (b) determining if additional regulations are applicable to crane operations.
- (c) ensuring that a qualified person is designated as the lift director.
- (d) ensuring that crane operations are coordinated with other jobsite activities that will be affected by or will affect lift operations.
- (e) ensuring that the area for the crane is adequately prepared. The preparation includes, but is not limited to, the following:
 - (1) access roads for the crane and associated equipment
 - (2) sufficient room to assemble and disassemble the crane
 - (3) an operating area that is suitable for the crane with respect to levelness, surface conditions, support capability, proximity to power lines, excavations, slopes, underground utilities, subsurface construction, and obstructions to crane operation
 - (4) traffic control as necessary to restrict unauthorized access to the crane's working area
- (f) ensuring that work involving the assembly and disassembly of a crane is supervised by a qualified person.
- (g) ensuring that crane operators meet the requirements of para. 5-3.1.2.
- (h) ensuring that conditions that may adversely affect crane operations are addressed. Such conditions include, but are not limited to, the following:
 - (1) poor soil conditions
 - (2) wind velocity or gusting winds
 - (3) heavy rain
 - (4) fog
 - (5) extreme cold
 - (6) artificial lighting
- (i) allowing crane operation near electric power lines only when the requirements of para. 5-3.4.5 have been met.
- (j) permitting special lifting operations only when equipment and procedures required by this Volume, the crane manufacturer, or a qualified person are employed. Such operations include, but are not limited to, the following:
 - (1) multiple crane lifts
 - (2) lifting personnel
 - (3) pick and carry operations
 - (4) multiple load line use
- (k) ensuring that work performed by a rigger (s) is supervised by a qualified person.
- (l) ensuring that crane maintenance is performed by personnel that meet the competence requirements in Section 5-03.

5-3.1.3.2.2 Lift Director

The lift director's responsibilities shall include the following:

- (a) being present at the jobsite during lifting operations.
- (b) stopping crane operations if alerted to an unsafe condition affecting those operations.
- (c) ensuring that the preparation of the area needed to support crane operations has been completed before crane operations commence.
- (d) ensuring necessary traffic controls are in place to restrict unauthorized access to the crane's work area
- (e) ensuring that personnel involved in crane operations understand their responsibilities, assigned duties, and the associated hazards.
- (f) addressing safety concerns raised by the operator or other personnel and being responsible if the lift director decides to overrule those concerns and directs crane operations to continue. (In all cases, the manufacturer's criteria for safe operation and the requirements of this Volume shall be adhered to.)
- (g) appointing the signalperson(s) and conveying that information to the crane operator.
- (h) ensuring that signalperson(s) appointed meet the requirements of Section 5-3.3.
- (i) allowing crane operation near electric power lines only when the requirements of para. 5-3.4.5 and any additional requirements determined by the site supervisor have been met.
- (j) ensuring precautions are implemented when hazards associated with special lifting operations are present. Such operations include, but are not limited to, the following:
 - (1) multiple crane lifts
 - (2) lifting personnel
 - (3) pick and carry operations
 - (4) mobile cranes operating on barges
 - (5) multiple load line use
- (k) ensuring that the applicable requirements of ASME B30.23 are met when lifting personnel.
- (l) informing the crane operator of the weight of loads to be lifted, as well as the lifting, moving, and placing locations for these loads.
- (m) obtaining the crane operator's verification that this weight does not exceed the crane's rated capacity.
- (n) ensuring that a crane's load rigging is performed by a rigger(s) that meets the compliance requirements in Section 5-0.3.

3.1.3.4 Responsibilities of the Rigger.

Riggers assigned to a load-handling activity shall, at a minimum, be responsible for the following:

- (a) ensuring the weight of the load and its approximate center of gravity have been obtained.
- (b) selecting the proper rigging equipment, inspecting it, and complying with the applicable operating practices according to the criteria of the applicable ASME B30 Volume (i.e., B30.9, B30.10, B30.20, B30.23, or B30.26).
- (c) ensuring the rated load of the rigging equipment as selected and configured is sufficient for the load to be handled, based on the number of legs, hitch configuration, and effects of angles.
- (d) properly attaching the rigging equipment to the hook, shackle, or other load-handling device.
- (e) ensuring that rigging equipment is adequately protected from abrasion, cutting, or other damage during load-handling activities.
- (f) rigging the load in a manner to ensure balance and stability during the load-handling activity.
- (g) knowing and understanding the applicable signals for equipment in use.
- (h) installing and using a tag line(s) when additional load control is required.



CHAPTER 2:
ASME B30.10-2014 – Hooks

Section 10-1: Selection, Use, and Maintenance

Reprinted from ASME B30.10, by permission of the American Society of Mechanical Engineers. All rights reserved.

This page intentionally left blank



Section 10-1: Selection, Use, and Maintenance

10-1.8: Identification

The manufacturer's identification and rated load identification shall be forged, cast, or die stamped on a low-stress and nonwearing area of the hook. Alternately, if the hook is used in conjunction with equipment described in other volumes of the B30 Standard, the equipment manufacturer's identification and rated load identification shall be forged, cast, or die stamped on a low-stress and nonwearing area of the hook.

10-1.10.6 Repairs and Modifications

- (a) Any conditions disclosed by the inspections performed in accordance with the requirements of para. 10-1.10.3 or 10-1.10.4 shall be corrected by repair or replacement before continuing to use the hook. All repairs and modifications shall be approved by the manufacturer or a qualified person.
- (b) Hooks having damage or wear described as follows shall be repaired or replaced:
 - (1) cracks, nicks, and gouges. Repair of cracks, nicks, and gouges shall be carried out by a designated person by grinding longitudinally, following the contour of the hook, provided no dimension is reduced more than 10% (or as recommended by the manufacturer) of its original value.
 - (2) wear exceeding 10% (or as recommended by the manufacturer) of the original sectional dimension
 - (3) any visibly apparent bend or twist from the plane of the unbent hook
 - (4) any distortion causing an increase in throat opening of 5%, not to exceed 1/4 in. (6 mm) (or as recommended by the manufacturer)
 - (5) inability of self-locking hooks to lock
- (c) A hook latch that is inoperative shall be repaired, replaced, or removed if not required.
- (d) If a required latch is inoperable and cannot be immediately repaired or replaced, the hook shall be sufficiently moused to retain loose items as defined in para. 10-1.3(c) until the latch is repaired or replaced.
- (e) When reassembling shank hooks, original securing methods or manufacturer's recommendations shall be followed.

- (f) All replacement parts shall be at least equal to the original manufacturer's specifications.
- (g) Hooks without provision for latches may be moused to retain loose items as defined in para. 10-1.3(c).
- (h) For special lifting applications where the throat opening is required to be closed, mousing may be used in place of the latch to retain loose items as defined in para. 10-1.3(c), when approved by a qualified person.

10-1.11: Operating Practices

10-1.11.1 Single Point Hooks

Personnel using hooks shall be aware of the following:

- (a) It shall be determined that the load to be applied does not exceed the lesser of the load rating of the hook or the load rating of the equipment of which the hook is a part.
- (b) Shock loading should be avoided.
- (c) Load shall be centered in the base (bowl/saddle) of the hook to prevent point loading of the hook.
- (d) When multileg slings are placed in the base (bowl/saddle) of the hook, the maximum included angle between sling legs shall be 90 deg or as determined by the hook manufacturer. The maximum sling leg angle with respect to the hook centerline for any rigging arrangement shall be 45 deg.
- (e) A collector ring, such as a link or shackle, should be used when more than two legs are placed in a hook or for angles greater than 45 deg with respect to the hook centerline.
- (f) Hooks shall not be used in such a manner as to place a side load, back load, or tip load on the hook.
- (g) When using a device to close the throat opening of the hook, care shall be taken that the load is not carried by the closing device.
- (h) Hands, fingers, and body shall be kept from between hook and load.
- (i) The use of a hook with a latch does not preclude the inadvertent detachment of a slack sling or a load from the hook. Hook latches aid in the retention of loose slings under slack rigging conditions only and are not intended to be antifouling devices during load handling or rigging. Visual verification of proper hook engagement is required in all cases.
- (j) Self-locking hooks shall be locked during use.

- (k) When a latch is equipped with a lock open device to facilitate rigging, the latch shall be closed during operation.
- (l) When a hook is equipped with a latch, the load shall not restrict the closure of the latch.
- (m) The need for a latch or mousing on any hook is a function of the application of the hook and shall be determined by a qualified person.

10-1.11.2 Duplex and Quad Hooks

Personnel using hooks shall be aware of the following:

- (a) For determining allowable sling angles for duplex (sister) and quad hooks, consult the manufacturer or a qualified person.
- (b) Duplex (sister) hooks shall be loaded equally on both sides unless the hook is specifically designed for single-point loading. When using an articulated duplex (sister) hook (see Fig. 10-1.1-5), care should be taken because articulation of the hook may cause instability in the slung load.
- (c) If the duplex (sister) hook is loaded at the pinhole instead of at the two saddles, the load applied shall not exceed the rated load that would normally be shared by the two saddles or the rated load of the supporting equipment.
- (d) Quad hook load handling shall be done with all prongs loaded and rigged to balance prong forces. The hook manufacturer or qualified person shall be consulted for two-prong and unbalanced-prong loading.
- (e) Hooks shall not be used in such a manner as to place a side load, back load, or tip load on the hook.
- (f) When using a device to close the throat opening of the hook, care shall be taken that the load is not carried by the closing device.
- (g) Hands, fingers, and body shall be kept from between hook and load.
- (h) The use of a hook with a latch does not preclude the inadvertent detachment of a slack sling or a load from the hook. Hook latches aid in the retention of loose slings under slack rigging conditions only and are not intended to be antifouling devices during load handling or rigging. Visual verification of proper hook engagement is required in all cases.
- (i) When a latch is equipped with a lock open device to facilitate rigging, the latch shall be closed during operation.
- (j) When a hook is equipped with a latch, the load shall not restrict the closure of the latch.
- (k) The need for a latch or mousing on any hook is a function of the application of the hook and shall be determined by a qualified person.



CHAPTER 3:
**ASME B30.20-2018 – Below the Hook
Lifting Devices**

**Section 20-1: Structural and
Mechanical Lifting Devices**

Reprinted from ASME B30.20, by permission of the American Society of Mechanical Engineers. All rights reserved.

This page intentionally left blank



Section 20-1: Structural and Mechanical Lifting Devices

Section 20-1.2: Marking, Construction, and Installation

20-1.2.1 Marking

- (a) *Rated Load.* The rated load of the lifting device shall be legibly marked on the main structure or on a tag attached to it where it is visible. If the lifting device is made up of several lifters, each detachable from the group, these lifters shall also be marked with their individual rated loads.
- (b) *Identification.* All new structural and mechanical lifting devices shall be marked with, but not limited to, the following information:
- (1) manufacturer's name and contact information
 - (2) serial number (unique unit identifier)
 - (3) lifter weight, if over 100 lb (45 kg)
 - (4) cold current (amps) (when applicable)
 - (5) rated voltage (when applicable)
 - (6) rated load [as described in (a)]
 - (7) ASME BTH-1 Design Category
 - (8) ASME BTH-1 Service Class

Section 20-1.3: Inspection, Testing, and Maintenance

20-1.3.2 Every Lift Inspection

Items such as the following shall be inspected by the operator before and/or during every lift for any indication of damage as specifically indicated, including observations during operation for any damage that might occur during the lift:

- (a) surface of the load for debris
- (b) condition and operation of the controls
- (c) condition and operation of the indicators and meters when installed

20-1.3.3 Frequent Inspection

Items such as the following shall be inspected for damage at intervals as defined in para. 20-1.3.1(b)(2), including observations during operation for any indications of damage that might appear between inspections. A qualified person shall determine whether any indications of damage constitute a hazard

or will require more frequent inspection. For all lifters, inspect:

- (a) structural members for deformation, cracks, or excessive wear on any part of the lifter
- (b) loose or missing guards, fasteners, covers, stops, or nameplates
- (c) all functional operating mechanisms and automatic hold-and-release mechanisms for misadjustments interfering with operation
- (d) missing or illegible operating control markings

Section 20-1.4: Operation

20-1.4.1 Operators

Below-the-hook lifting devices shall be operated only by trained, designated persons.

20-1.4.2 Qualifications

Qualifications for operators of below-the-hook lifting devices are as follows:

- (a) The operator shall be instructed in the use of the device by a designated person. Instructions should include, but not be limited to, the following:
 - (1) application of the lifter to the load and material-handling device, and adjustments, if any, that adapt the lifter to various sizes or kinds of loads
 - (2) instructions in any special operations or precautions
 - (3) the manufacturer's suggested operating procedures
 - (4) condition of the load itself required for operation of the lifter, such as, but not limited to, balance, surface cleanliness, flatness, bending, and load thickness
 - (5) storage of the lifter to protect it from damage
 - (6) not exceeding the rated load of the lifting device nor the capacity of the hoisting equipment by the combined weight of the load, the lifting device, and rigging
 - (7) the proper attachment of adapters to lifting device for special load handling
- (b) The operator shall demonstrate the ability to operate the lifter as instructed before assuming responsibility for using the lifter.

- (c) The operator shall demonstrate an understanding of standard hand signals when applicable

20-1.4.3 Responsibilities

While the organizational structure of various projects may differ, the following roles are described here for purposes of delineating responsibilities. All responsibilities listed below shall be assigned in the worksite organization. (A single individual may perform one or more of these roles.)

operator: directly controls the lifting device's functions.

owner: has custodial control of a lifting device by virtue of lease or ownership.

These persons and roles may or may not match the persons and roles associated with the hoisting equipment in use.

20-1.4.3.1 Responsibilities of the Lifting Device Owner.

The responsibilities of the lifting device owner shall include the following:

- (a) providing a lifting device, and all necessary components specified by the manufacturer, that meets the requirements of Sections 20-1.2 and 20-1.3 as well as specific job requirements.
- (b) providing all applicable operating instructions.
- (c) providing field assembly, and disassembly (if applicable), operation and maintenance information, and warning decals and placards installed as prescribed by the lifting device manufacturer.
- (d) establishing an inspection, testing, and maintenance program in accordance with Section 20-1.3.
- (e) using designated personnel to perform the required maintenance, repair, and inspections.
- (f) ensuring that the lifting device is in proper operating condition prior to initial use at the worksite by the following:
 - (1) verifying that all inspections have been performed as required by Section 20-1.3
 - (2) verifying that the lifting device has the necessary lifting capacity to perform the proposed lifting operations in the planned configuration
- (g) using operators that meet the requirements of para.20-1.4.2.
- (h) ensuring that all personnel involved in maintenance, repair, assembly, disassembly, and inspection are aware of their responsibilities, assigned duties, and the associated hazards.
- (i) determining if additional regulations are applicable to lifting device operations.

- (j) ensuring that conditions that may adversely affect lifting device operations are addressed. Such conditions include, but are not limited to, the following:
 - (1) wind velocity or gusting winds
 - (2) precipitation
 - (3) fog
 - (4) extreme temperatures
 - (5) lighting
- (k) addressing safety concerns raised by the operator or other personnel and being responsible if he and a qualified person decide to overrule those concerns and directs lifting device operations to continue. (In all cases, the manufacturer's criteria for safe operation and the requirements of this Volume shall be followed.)

20-1.4.3.2 Responsibilities of Operators.

The operator shall be responsible for the following listed items. The operator shall not be responsible for hazards or conditions that are not under his direct control and that adversely affect operation of the lifting device. Whenever the operator has doubt as to the safety of lifting device operations, the operator shall place the load in a safe condition and stop the lifting device's functions in a controlled manner. Use of the lifting device shall resume only after safety concerns have been addressed or the continuation of lifting device operations is directed by the owner.

The operator's responsibilities shall include the following:

- (a) reviewing the requirements for the lifting device with the owner before operations.
- (b) knowing what types of site conditions could adversely affect the operation of the lifting device and consulting with the owner concerning the possible presence of those conditions.
- (c) understanding and applying the information contained in the lifting device manufacturer's operating manual.
- (d) understanding the lifting device's functions and limitations as well as its particular operating characteristics.
- (e) ensuring an inspection is performed prior to every lift as specified in para. 20-1.3.2.
- (f) promptly reporting the need for any adjustments or repairs to a designated person.
- (g) following applicable lock out/tag out procedures.
- (h) not operating the lifting device when physically or mentally unfit.
- (i) ensuring that all controls are in the off or neutral position and that all personnel are in the clear before energizing the lifting device.

- (j) not engaging in any practice that will divert his attention while operating the lifting device.
- (k) testing the lifting device function controls that will be used and operating the lifting device only if those function controls respond properly.
- (l) operating the lifting device's functions, under normal operating conditions, in a smooth and controlled manner.
- (m) knowing and following the procedures specified by the manufacturer or approved by a qualified person, for assembly, disassembly, setting up, and reeving/rigging of the lifting device.
- (n) considering all factors known that might affect the lifting device capacity and informing the owner of the need to make appropriate adjustments.
- (o) understanding basic load attachment procedures.
- (p) responding only to instructions from designated persons. However, the operator shall obey a stop order at all times, no matter who gives it.
- (q) ensuring that all personnel shall stay clear of the load
- (h) The temperature of the load should not exceed the maximum allowable limits of the lifter.
- (i) Verify that the load is well secured and properly balanced in the lifting device when it is initially lifted.
- (j) Do not allow load or lifter to come into contact with any obstruction.
- (k) The operator shall ensure that the lifting device is adequately protected from damage during use.
- (l) The lifter shall not be used for side pulls or sliding the load unless specifically authorized by a qualified person.
- (m) The operator shall land any attached load and store the lifter before leaving the lifting device. The operator shall not leave suspended loads unattended.
- (n) The operator shall not ride, or allow others to ride loads or the lifting device.
- (o) The operation of the lifter shall be observed during use. Any deficiency observed shall be examined by a designated person. If the deficiency constitutes a hazard, the lifter shall be removed from service and tagged "Out of Service." Any indication of a hazardous condition shall be reported to a qualified person for evaluation.
- (p) Loads shall be guided in such a manner as to avoid endangering hands or other body parts as the load is moved, or if it drops.

20-1.4.4 Lifting Device Operating Practices

- (a) Lifting devices shall be operated only by the following qualified personnel:
 - (1) designated persons
 - (2) trainees under the supervision of a designated person, the number of trainees permitted to be supervised by a single designated person, the physical location of the designated person while supervising, and the type of communication required between the designated person and the trainee shall be determined by a qualified person
 - (3) maintenance and test personnel, when it is necessary in the performance of their duties
 - (4) inspectors (lifting devices)
- (b) Ensure the weight of the load and its approximate center of gravity have been obtained, provided, or calculated.
- (c) The lifting device shall not be loaded in excess of its rated load or handle any load for which it is not designed.
- (d) Properly attaching the lifting device to the hook, shackle, or other load handling device.
- (e) The lifter shall be applied to the load in accordance with the instruction manual.
- (f) Before lifting, the operator shall make sure that lifter ropes or chains are not kinked, and that multiple part lines are not twisted around each other.
- (g) Care should be taken to make certain the load is correctly distributed for the lifter being used.

20-1.4.5 Miscellaneous Operating Practices

- (a) An operator shall not use a lifting device that is tagged "Out of Service" or otherwise designated as non-functioning.
- (b) "Out of Service" tags on lifting devices shall not be removed without the approval of the person placing them or a designated person.
- (c) The lifter, when not in use, should be stored at an assigned location.
- (d) Caution should be taken that operating markings or tags shall not be removed or defaced. Missing or illegible markings or tags shall be replaced.

20-1.5 Instruction Manuals

Operating instructions and maintenance and parts information shall be furnished by the manufacturer.



CHAPTER 4:
OSHA 1910.184 – Slings

OSHA 1910.184 – Slings

Reprinted from Occupational Safety and Health Administration (OSHA) standard. All rights reserved.

This page intentionally left blank



OSHA 1910.184 – Slings

Regulations 1910.184

- Part Number: 1910
- Part Title: Occupational Safety and Health Standards
- Subpart: N
- Subpart Title: Materials Handling and Storage
- Standard Number: 1910.184
- Title: Slings

§ 1910.184 Slings

(a) **Scope.** This section applies to slings used in conjunction with other material handling equipment for the movement of material by hoisting, in employments covered by this part. The types of slings covered are those made from alloy steel chain, wire rope, metal mesh, natural or synthetic fiber rope (conventional three strand construction), and synthetic web (nylon, polyester, and polypropylene).

(b) **Definitions.**

Angle of loading is the inclination of a leg or branch of a sling measured from the horizontal or vertical plane as shown in *Fig. N-184-5*; provided that an angle of loading of five degrees or less from the vertical may be considered a vertical angle of loading.

Basket hitch is a sling configuration whereby the sling is passed under the load and has both ends, end attachments, eyes or handles on the hook or a single master link.

Braided wire rope is a wire rope formed by plaiting component wire ropes.

Bridle wire rope sling is a sling composed of multiple wire rope legs with the top ends gathered in a fitting that goes over the lifting hook.

Cable laid endless sling—mechanical joint is a wire rope sling made endless by joining the ends of a single length of cable laid rope with one or more metallic fittings.

Cable laid grommet—hand tucked is an endless wire rope sling made from one length of rope wrapped six times around a core formed by

hand tucking the ends of the rope inside the six wraps.

Cable laid rope is a wire rope composed of six wire ropes wrapped around a fiber or wire rope core.

Cable laid rope sling—mechanical joint is a wire rope sling made from a cable laid rope with eyes fabricated by pressing or swaging one or more metal sleeves over the rope junction.

Choker hitch is a sling configuration with one end of the sling passing under the load and through an end attachment, handle or eye on the other end of the sling.

Coating is an elastomer or other suitable material applied to a sling or to a sling component to impart desirable properties.

Cross rod is a wire used to join spirals of metal mesh to form a complete fabric. (*See Fig. N-184-2.*)

Designated means selected or assigned by the employer or the employer's representative as being qualified to perform specific duties.

Equivalent entity is a person or organization (including an employer) which, by possession of equipment, technical knowledge and skills, can perform with equal competence the same repairs and tests as the person or organization with which it is equated.

Fabric (metal mesh) is the flexible portion of a metal mesh sling consisting of a series of transverse coils and cross rods.

Female handle (choker) is a handle with a handle eye and a slot of such dimension as to permit passage of a male handle thereby allowing the use of a metal mesh sling in a choker hitch. (*See Fig. N-184-1.*)

Handle is a terminal fitting to which metal mesh fabric is attached. (*See Fig. N-184-1.*)

Handle eye is an opening in a handle of a metal mesh sling shaped to accept a hook, shackle or other lifting device. (*See Fig. N-184-1.*)

Hitch is a sling configuration whereby the sling is fastened to an object or load, either directly to it or around it.

Link is a single ring of a chain.

Male handle (triangle) is a handle with a handle eye.

Master coupling link is an alloy steel welded coupling link used as an intermediate link to join alloy steel chain to master links. (See Fig. N-184-3.)

Master link or *gathering ring* is a forged or welded steel link used to support all members (legs) of an alloy steel chain sling or wire rope sling. (See Fig. N-184-3.)

Mechanical coupling link is a non-welded, mechanically closed steel link used to attach master links, hooks, etc., to alloy steel chain.

Proof load is the load applied in performance of a proof test.

Proof test is a nondestructive tension test performed by the sling manufacturer or an equivalent entity to verify construction and workmanship of a sling.

Rated capacity or *working load limit* is the maximum working load permitted by the provisions of this section.

Reach is the effective length of an alloy steel chain sling measured from the top bearing surface of the upper terminal component to the bottom bearing surface of the lower terminal component.

Selvage edge is the finished edge of synthetic webbing designed to prevent unraveling.

Sling is an assembly which connects the load to the material handling equipment.

Sling manufacturer is a person or organization that assembles sling components into their final form for sale to users.

Spiral is a single transverse coil that is the basic element from which metal mesh is fabricated. (See Fig. N-184-2.)

Straight-line hitch is a method of supporting a load by a single, vertical part or leg of the sling. (See Fig. N-184-4.)

Strand laid endless sling—mechanical joint is a wire rope sling made endless from one length of rope with the ends joined by one or more metallic fittings.

Strand laid grommet—hand tucked is an endless wire rope sling made from one length of strand wrapped six times around a core formed by hand tucking the ends of the strand inside the six wraps.

Strand laid rope is a wire rope made with strands (usually six or eight) wrapped around a fiber core, wire strand core, or independent wire rope core (IWRC).

(c) **Safe operating practices.** Whenever any sling is used, the following practices shall be observed:

- (1) Slings that are damaged or defective shall not be used.
- (2) Slings shall not be shortened with knots or bolts or other makeshift devices.
- (3) Sling legs shall not be kinked.
- (4) Slings shall not be loaded in excess of their rated capacities.
- (5) Slings used in a basket hitch shall have the loads balanced to prevent slippage.
- (6) Slings shall be securely attached to their loads.
- (7) Slings shall be padded or protected from the sharp edges of their loads.
- (8) Suspended loads shall be kept clear of all obstructions.
- (9) All employees shall be kept clear of loads about to be lifted and of suspended loads.
- (10) Hands or fingers shall not be placed between the sling and its load while the sling is being tightened around the load.
- (11) Shock loading is prohibited.
- (12) A sling shall not be pulled from under a load when the load is resting on the sling.
- (13) Employers must not load a sling in excess of its recommended safe working load as prescribed by the sling manufacturer on the identification markings permanently affixed to the sling.
- (14) Employers must not use slings without affixed and legible identification markings.

(d) **Inspections.** Each day before being used, the sling and all fastenings and attachments shall be inspected for damage or defects by a competent person designated by the employer. Additional inspections shall be performed during sling use, where service conditions warrant. Damaged or defective slings shall be immediately removed from service.

(e) **Alloy steel chain slings.**

- (1) **Sling identification.** Alloy steel chain slings shall have permanently affixed durable identification stating size, grade, rated capacity, and reach.
- (2) **Attachments.**
 - (i) Hooks, rings, oblong links, pear shaped links, welded or mechanical coupling links or other attachments shall have a rated capacity at least equal to that of the alloy steel chain with which they are used or the sling shall not be used in excess of the rated capacity of the weakest component.

- (ii) Makeshift links or fasteners formed from bolts or rods, or other such attachments, shall not be used.
- (3) *Inspections.*
 - (i) In addition to the inspection required by paragraph (d) of this section, a thorough periodic inspection of alloy steel chain slings in use shall be made on a regular basis, to be determined on the basis of (A) frequency of sling use; (B) severity of service conditions; (C) nature of lifts being made; and (D) experience gained on the service life of slings used in similar circumstances. Such inspections shall in no event be at intervals greater than once every 12 months.
 - (ii) The employer shall make and maintain a record of the most recent month in which each alloy steel chain sling was thoroughly inspected, and shall make such record available for examination.
 - (iii) The thorough inspection of alloy steel chain slings shall be performed by a competent person designated by the employer, and shall include a thorough inspection for wear, defective welds, deformation and increase in length. Where such defects or deterioration are present, the sling shall be immediately removed from service.
- (4) *Proof testing.* The employer shall ensure that before use, each new, repaired, or reconditioned alloy steel chain sling, including all welded components in the sling assembly, shall be proof tested by the sling manufacturer or equivalent entity, in accordance with paragraph 5.2 of the American Society of Testing and Materials Specification A391-65, which is incorporated by reference as specified in Sec. 1910.6 (ANSI G61.1-1968). The employer shall retain a certificate of the proof test and shall make it available for examination.
- (5) [Reserved]
- (6) *Safe operating temperatures.* Employers must permanently remove an alloy steel-chain slings from service if it is heated above 1000 degrees F. When exposed to service temperatures in excess of 600 degrees F, employers must reduce the maximum working-load limits permitted by the chain manufacturer in accordance with the chain or sling manufacturer's recommendations.
- (7) *Repairing and reconditioning alloy steel chain slings.*
 - (i) Worn or damaged alloy steel chain slings or attachments shall not be used until repaired. When welding or heat testing is performed, slings shall not be used unless repaired,

reconditioned and proof tested by the sling manufacturer or an equivalent entity.

- (ii) Mechanical coupling links or low carbon steel repair links shall not be used to repair broken lengths of chain.
- (8) *Effects of wear.* If the chain size at any point of any link is less than that stated in Table N-184-1, the sling shall be removed from service.

**TABLE N-184-1.
MINIMUM ALLOWABLE CHAIN SIZE
AT ANY POINT OF LINK**

Chain size, inches	Minimum allowable chain size, inches
1/4	13/64
3/8	19/64
1/2	25/64
5/8	31/64
3/4	19/32
7/8	45/64
1	13/16
1 1/8	29/32
1 1/4	1
1 3/8	1 3/32
1 1/2	1 3/16
1 3/4	1 13/32

- (9) *Deformed attachments.*
 - (i) Alloy steel chain slings with cracked or deformed master links, coupling links or other components shall be removed from service.
 - (ii) Slings shall be removed from service if hooks are cracked, have been opened more than 15 percent of the normal throat opening measured at the narrowest point or twisted more than 10 degrees from the plane of the unbent hook.
- (f) *Wire rope slings.*
 - (1) *Sling use.* Employers must use only wire-rope slings that have permanently affixed and legible identification markings as prescribed by the manufacturer, and that indicate the recommended safe working load for the type(s) of hitch(es) used, the angle upon which it is based, and the number of legs if more than one.
 - (2) *Minimum sling lengths.*
 - (i) Cable laid and 6x19 and 6x37 slings shall have a minimum clear length of wire rope 10 times the component rope diameter between splices, sleeves or end fittings.
 - (ii) Braided slings shall have a minimum clear length of wire rope 40 times the component

- rope diameter between the loops or end fittings.
- (iii) Cable laid grommets, strand laid grommets and endless slings shall have a minimum circumferential length of 96 times their body diameter.
- (3) *Safe operating temperatures.* Fiber core wire rope slings of all grades shall be permanently removed from service if they are exposed to temperatures in excess of 200 deg. F. When nonfiber core wire rope slings of any grade are used at temperatures above 400 deg. F or below minus 60 deg. F, recommendations of the sling manufacturer regarding use at that temperature shall be followed.
- (4) *End attachments.*
- (i) Welding of end attachments, except covers to thimbles, shall be performed prior to the assembly of the sling.
- (ii) All welded end attachments shall not be used unless proof tested by the manufacturer or equivalent entity at twice their rated capacity prior to initial use. The employer shall retain a certificate of the proof test, and make it available for examination.
- (5) *Removal from service.* Wire rope slings shall be immediately removed from service if any of the following conditions are present:
- (i) Ten randomly distributed broken wires in one rope lay, or five broken wires in one strand in one rope lay.
- (ii) Wear or scraping of one-third the original diameter of outside individual wires.
- (iii) Kinking, crushing, bird caging or any other damage resulting in distortion of the wire rope structure.
- (iv) Evidence of heat damage.
- (v) End attachments that are cracked, deformed or worn.
- (vi) Hooks that have been opened more than 15 percent of the normal throat opening measured at the narrowest point or twisted more than 10 degrees from the plane of the unbent hook.
- (vii) Corrosion of the rope or end attachments.
- (g) *Metal mesh slings.*
- (1) *Sling marking.* Each metal mesh sling shall have permanently affixed to it a durable marking that states the rated capacity for vertical basket hitch and choker hitch loadings.
- (2) *Handles.* Handles shall have a rated capacity at least equal to the metal fabric and exhibit no deformation after proof testing.
- (3) *Attachments of handles to fabric.* The fabric and handles shall be joined so that:
- (i) The rated capacity of the sling is not reduced.
- (ii) The load is evenly distributed across the width of the fabric.
- (iii) Sharp edges will not damage the fabric.
- (4) *Sling coatings.* Coatings which diminish the rated capacity of a sling shall not be applied.
- (5) *Sling testing.* All new and repaired metal mesh slings, including handles, shall not be used unless proof tested by the manufacturer or equivalent entity at a minimum of 1 1/2 times their rated capacity. Elastomer impregnated slings shall be proof tested before coating.
- (6) [Reserved]
- (7) *Safe operating temperatures.* Metal mesh slings which are not impregnated with elastomers may be used in a temperature range from minus 20 deg. F to plus 550 deg. F without decreasing the working load limit. Metal mesh slings impregnated with polyvinyl chloride or neoprene may be used only in a temperature range from zero degrees to plus 200 deg. F. For operations outside these temperature ranges or for metal mesh slings impregnated with other materials, the sling manufacturer's recommendations shall be followed.
- (8) *Repairs.*
- (i) Metal mesh slings which are repaired shall not be used unless repaired by a metal mesh sling manufacturer or an equivalent entity.
- (ii) Once repaired, each sling shall be permanently marked or tagged, or a written record maintained, to indicate the date and nature of the repairs and the person or organization that performed the repairs. Records of repairs shall be made available for examination.
- (9) *Removal from service.* Metal mesh slings shall be immediately removed from service if any of the following conditions are present:
- (i) A broken weld or broken brazed joint along the sling edge.
- (ii) Reduction in wire diameter of 25 percent due to abrasion or 15 percent due to corrosion.
- (iii) Lack of flexibility due to distortion of the fabric.
- (iv) Distortion of the female handle so that the depth of the slot is increased more than 10 percent.
- (v) Distortion of either handle so that the width of the eye is decreased more than 10 percent.
- (vi) A 15 percent reduction of the original cross sectional area of metal at any point around the handle eye.
- (vii) Distortion of either handle out of its plane.

(h) **Natural and synthetic fiber rope slings.**

- (1) **Sling use.** Employers must use natural and synthetic fiber-rope slings that have permanently affixed and legible identification markings stating the rated capacity for the type(s) of hitch(es) used and the angle upon which it is based, type of fiber material, and the number of legs if more than one. (See Fig. N-184-4 and Fig. N-184-5.)
- (2) **Safe operating temperatures.** Natural and synthetic fiber rope slings, except for wet frozen slings, may be used in a temperature range from minus 20 deg. F to plus 180 deg. F without decreasing the working load limit. For operations outside this temperature range and for wet frozen slings, the sling manufacturer's recommendations shall be followed.
- (3) **Splicing.** Spliced fiber rope slings shall not be used unless they have been spliced in accordance with the following minimum requirements and in accordance with any additional recommendations of the manufacturer:
 - (i) In manila rope, eye splices shall consist of at least three full tucks, and short splices shall consist of at least six full tucks, three on each side of the splice center line.
 - (ii) In synthetic fiber rope, eye splices shall consist of at least four full tucks, and short splices shall consist of at least eight full tucks, four on each side of the center line.
 - (iii) Strand end tails shall not be trimmed flush with the surface of the rope immediately adjacent to the full tucks. This applies to all types of fiber rope and both eye and short splices. For fiber rope under one inch in diameter, the tail shall project at least six rope diameters beyond the last full tuck. For fiber rope one inch in diameter and larger, the tail shall project at least six inches beyond the last full tuck. Where a projecting tail interferes with the use of the sling, the tail shall be tapered and spliced into the body of the rope using at least two additional tucks (which will require a tail length of approximately six rope diameters beyond the last full tuck).
 - (iv) Fiber rope slings shall have a minimum clear length of rope between eye splices equal to 10 times the rope diameter.
 - (v) Knots shall not be used in lieu of splices.
 - (vi) Clamps not designed specifically for fiber ropes shall not be used for splicing.
 - (vii) For all eye splices, the eye shall be of such size to provide an included angle of not greater than 60 degrees at the splice when the eye is placed over the load or support.
- (4) **End attachments.** Fiber rope slings shall not be used if end attachments in contact with the rope have sharp edges or projections.
- (5) **Removal from service.** Natural and synthetic fiber rope slings shall be immediately removed from service if any of the following conditions are present:
 - (i) Abnormal wear.
 - (ii) Powdered fiber between strands.
 - (iii) Broken or cut fibers.
 - (iv) Variations in the size or roundness of strands.
 - (v) Discoloration or rotting.
 - (vi) Distortion of hardware in the sling.
- (6) **Repairs.** Only fiber rope slings made from new rope shall be used. Use of repaired or reconditioned fiber rope slings is prohibited.
- (i) **Synthetic web slings --**
 - (1) **Sling identification.** Each sling shall be marked or coded to show the rated capacities for each type of hitch and type of synthetic web material.
 - (2) **Webbing.** Synthetic webbing shall be of uniform thickness and width and selvage edges shall not be split from the webbing's width.
 - (3) **Fittings.** Fittings shall be:
 - (i) Of a minimum breaking strength equal to that of the sling; and
 - (ii) Free of all sharp edges that could in any way damage the webbing.
 - (4) Attachment of end fittings to webbing and formation of eyes. Stitching shall be the only method used to attach end fittings to webbing and to form eyes. The thread shall be in an even pattern and contain a sufficient number of stitches to develop the full breaking strength of the sling.
 - (5) [Reserved]
 - (6) **Environmental conditions.** When synthetic web slings are used, the following precautions shall be taken:
 - (i) Nylon web slings shall not be used where fumes, vapors, sprays, mists or liquids of acids or phenolics are present.
 - (ii) Polyester and polypropylene web slings shall not be used where fumes, vapors, sprays, mists or liquids of caustics are present.
 - (iii) Web slings with aluminum fittings shall not be used where fumes, vapors, sprays, mists or liquids of caustics are present. (See Fig. N-184-6.)
 - (7) **Safe operating temperatures.** Synthetic web slings of polyester and nylon shall not be used at temperatures in excess of 180 deg. F. Polypropylene web slings shall not be used at temperatures in excess of 200 deg. F.

(8) *Repairs.*

- (i) Synthetic web slings which are repaired shall not be used unless repaired by a sling manufacturer or an equivalent entity.
- (ii) Each repaired sling shall be proof tested by the manufacturer or equivalent entity to twice the rated capacity prior to its return to service. The employer shall retain a certificate of the proof test and make it available for examination.
- (iii) Slings, including webbing and fittings, which have been repaired in a temporary manner shall not be used.

(9) *Removal from service.* Synthetic web slings shall be immediately removed from service if any of the following conditions are present:

- (i) Acid or caustic burns;
- (ii) Melting or charring of any part of the sling surface;
- (iii) Snags, punctures, tears or cuts;
- (iv) Broken or worn stitches; or
- (v) Distortion of fittings.

FIGURE N-184-1 METAL MESH SLING (TYPICAL)

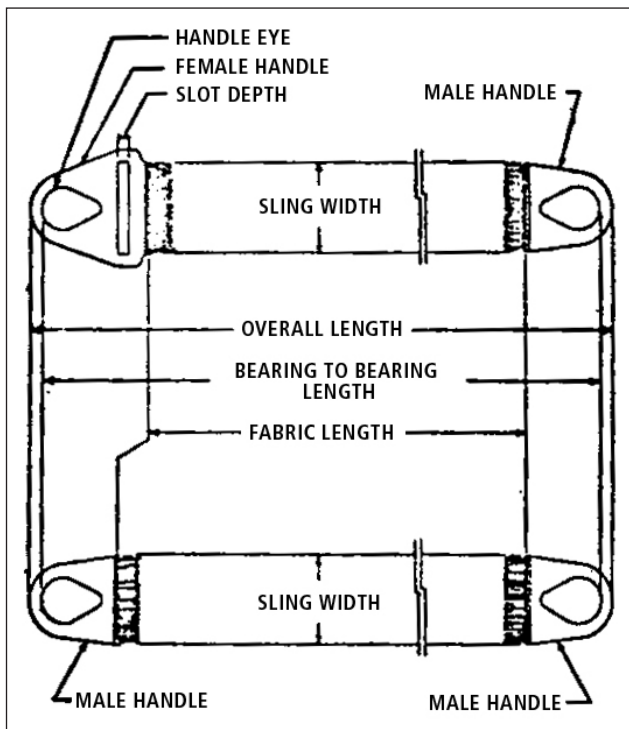

FIGURE N-184-2 METAL MESH CONSTRUCTION

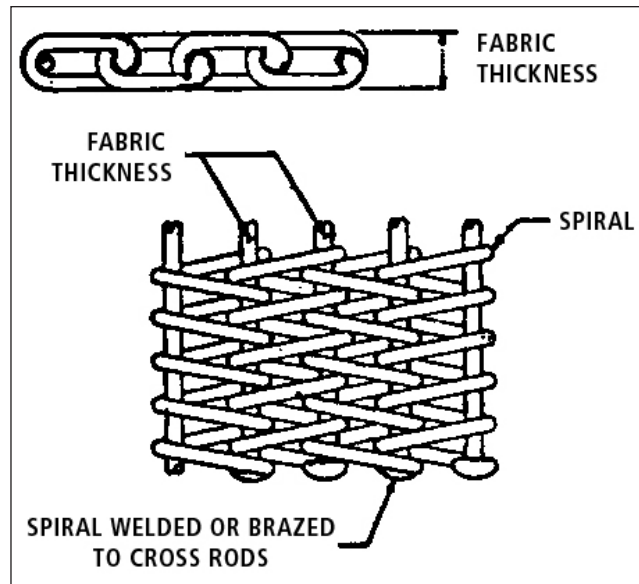

FIGURE N-184-3 MAJOR COMPONENTS OF A QUADRUPLE SLING

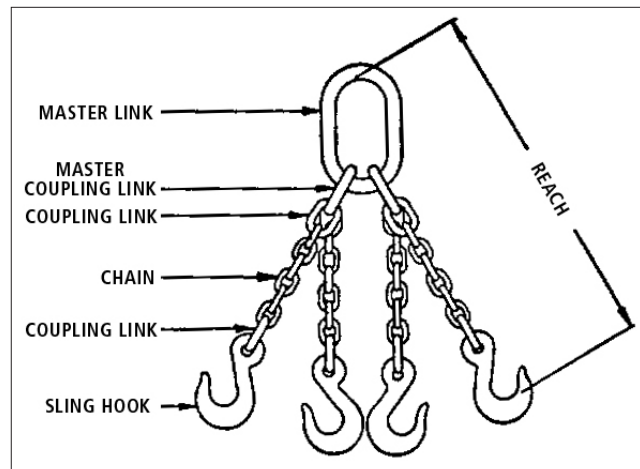

FIGURE N-184-4 BASIC SLING CONFIGURATIONS WITH VERTICAL LEGS

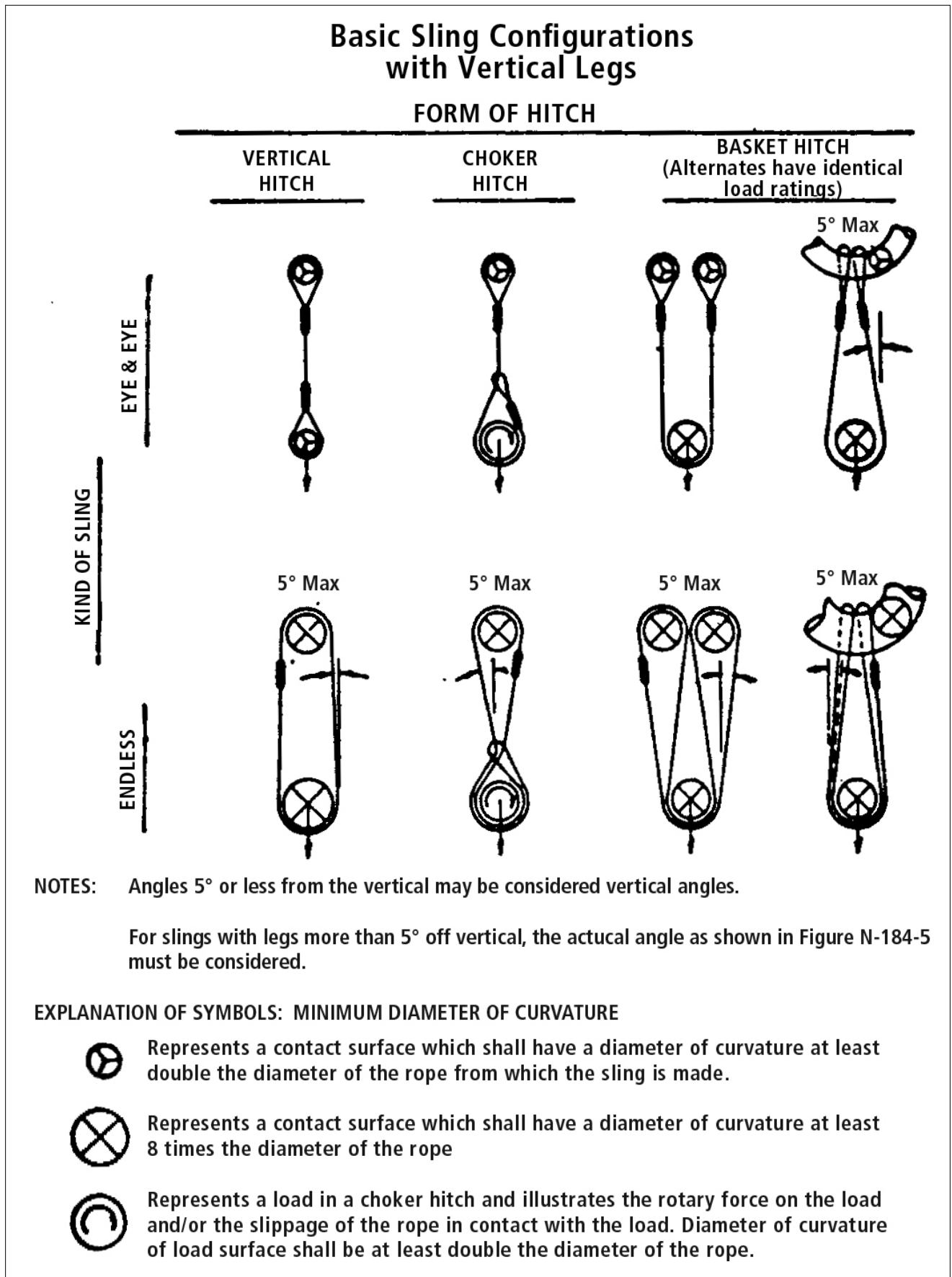

FIGURE N-184-5 SLING CONFIGURATIONS WITH ANGLED LEGS

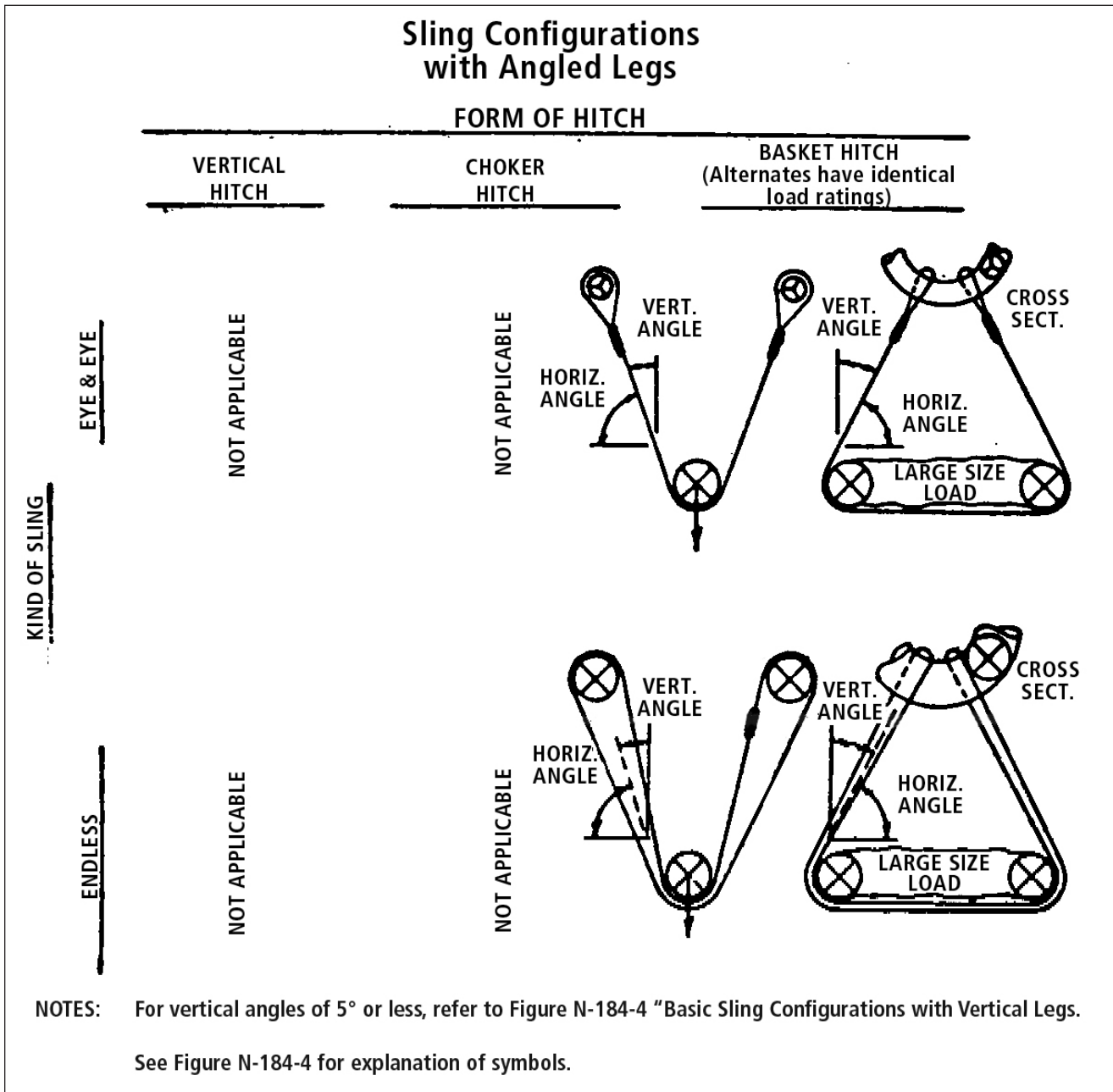
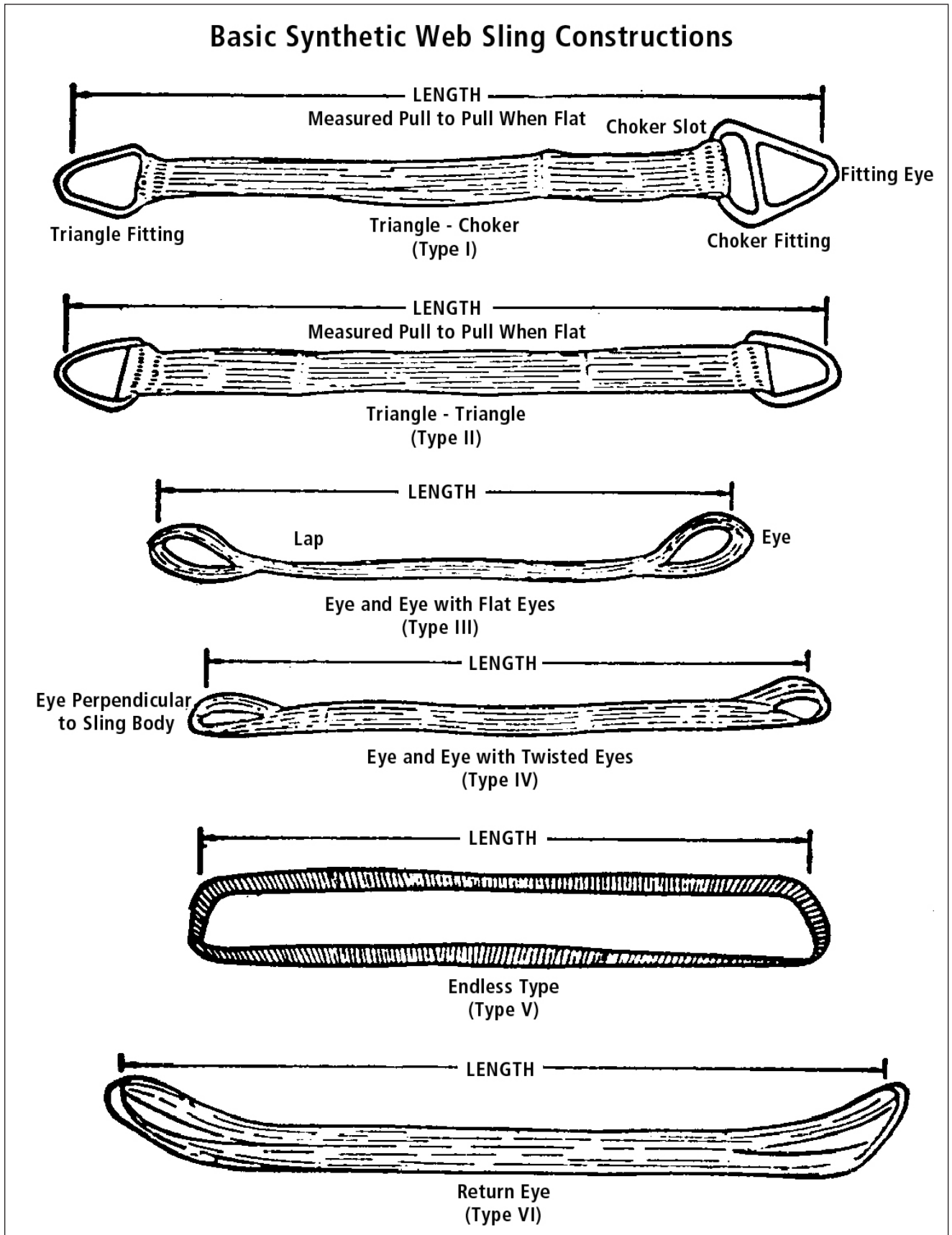

FIGURE N-184-6 BASIC SYNTHETIC WEB SLING CONSTRUCTIONS



This page intentionally left blank



CHAPTER 5:
**OSHA 1926.251 – Rigging Equipment for
Material Handling**

**OSHA 1926.251 – Rigging
Equipment for Material Handling**

Reprinted from Occupational Safety and Health Administration
(OSHA) standard. All rights reserved.

This page intentionally left blank



OSHA 1926.251 – Rigging Equipment for Material Handling

Regulations 1926.251

- Part Number: 1926
- Part Title: Occupational Safety and Health Standards
- Subpart: H
- Subpart Title: Materials Handling, Storage, Use, and Disposal
- Standard Number: 1926.251
- Title: Rigging equipment for material handling
- Applicable Standards: 1910.184(a); 1910.184(c)(2); 1910.184(c)(3); 1910.184(c)(5); 1910.184(c)(7); 1910.184(c)(10); 1910.184(c)(11); 1910.184(c)(12); 1910.184(f)(2); 1910.184(f)(3); 1910.184(f)(4); 1910.184(d)

§ 1926.251 Rigging Equipment for Material Handling

(a) General.

- (1) Rigging equipment for material handling shall be inspected prior to use on each shift and as necessary during its use to ensure that it is safe. Defective rigging equipment shall be removed from service.
- (2) Employers must ensure that rigging equipment:
 - (i) Has permanently affixed and legible identification markings as prescribed by the manufacturer that indicate the recommended safe working load;
 - (ii) Not be loaded in excess of its recommended safe working load as prescribed on the identification markings by the manufacturer; and
 - (iii) Not be used without affixed, legible identification markings, required by paragraph (a)(2)(i) of this section.
- (3) Rigging equipment, when not in use, shall be removed from the immediate work area so as not to present a hazard to employees.
- (4) Special custom design grabs, hooks, clamps, or other lifting accessories, for such units as modular panels, prefabricated structures and similar materials, shall be marked to indicate the safe working loads and shall be proof-tested prior to use to 125 percent of their rated load.

(5) “Scope.” This section applies to slings used in conjunction with other material handling equipment for the movement of material by hoisting, in employments covered by this part. The types of slings covered are those made from alloy steel chain, wire rope, metal mesh, natural or synthetic fiber rope (conventional three strand construction), and synthetic web (nylon, polyester, and polypropylene).

(6) “Inspections.” Each day before being used, the sling and all fastenings and attachments shall be inspected for damage or defects by a competent person designated by the employer. Additional inspections shall be performed during sling use, where service conditions warrant. Damaged or defective slings shall be immediately removed from service.

(b) Alloy steel chains.

- (1) Welded alloy steel chain slings shall have permanently affixed durable identification stating size, grade, rated capacity, and sling manufacturer.
- (2) Hooks, rings, oblong links, pear-shaped links, welded or mechanical coupling links, or other attachments, when used with alloy steel chains, shall have a rated capacity at least equal to that of the chain.
- (3) Job or shop hooks and links, or makeshift fasteners, formed from bolts, rods, etc., or other such attachments, shall not be used.
- (4) Employers must not use alloy steel-chain slings with loads in excess of the rated capacities (i.e., working load limits) indicated on the sling by permanently affixed and legible identification markings prescribed by the manufacturer.
- (5) Whenever wear at any point of any chain link exceeds that shown in Table H-1, the assembly shall be removed from service.
- (6) “Inspections.”
 - (i) In addition to the inspection required by other paragraphs of this section, a thorough periodic inspection of alloy steel chain slings in use shall be made on a regular basis, to be determined on the basis of (A) frequency of sling use; (B) severity of service conditions; (C) nature of lifts being made; and (D) experience gained on the service life of slings used in similar circumstances. Such inspections

shall in no event be at intervals greater than once every 12 months.

- (ii) The employer shall make and maintain a record of the most recent month in which each alloy steel chain sling was thoroughly inspected, and shall make such record available for examination.

(c) Wire rope.

- (1) Employers must not use improved plow-steel wire rope and wire-rope slings with loads in excess of the rated capacities (i.e., working load limits) indicated on the sling by permanently affixed and legible identification markings prescribed by the manufacturer.
- (2) Protruding ends of strands in splices on slings and bridles shall be covered or blunted.
- (3) Wire rope shall not be secured by knots, except on haul back lines on scrapers.
- (4) The following limitations shall apply to the use of wire rope:
 - (i) An eye splice made in any wire rope shall have not less than three full tucks. However, this requirement shall not operate to preclude the use of another form of splice or connection which can be shown to be as efficient and which is not otherwise prohibited.
 - (ii) Except for eye splices in the ends of wires and for endless rope slings, each wire rope used in hoisting or lowering, or in pulling loads, shall consist of one continuous piece without knot or splice.
 - (iii) Eyes in wire rope bridles, slings, or bull wires shall not be formed by wire rope clips or knots.
 - (iv) Wire rope shall not be used if, in any length of eight diameters, the total number of visible broken wires exceeds 10 percent of the total number of wires, or if the rope shows other signs of excessive wear, corrosion, or defect.
- (5) When U-bolt wire rope clips are used to form eyes, Table H-2 shall be used to determine the number and spacing of clips.
 - (i) When used for eye splices, the U-bolt shall be applied so that the “U” section is in contact with the dead end of the rope.
 - (ii) [Reserved]
- (6) Slings shall not be shortened with knots or bolts or other makeshift devices.
- (7) Sling legs shall not be kinked.
- (8) Slings used in a basket hitch shall have the loads balanced to prevent slippage.
- (9) Slings shall be padded or protected from the sharp edges of their loads.

(10) Hands or fingers shall not be placed between the sling and its load while the sling is being tightened around the load.

(11) Shock loading is prohibited.

(12) A sling shall not be pulled from under a load when the load is resting on the sling.

(13) “Minimum sling lengths.”

(i) Cable laid and 6 X 19 and 6 X 37 slings shall have minimum clear length of wire rope 10 times the component rope diameter between splices, sleeves or end fittings.

(ii) Braided slings shall have a minimum clear length of wire rope 40 times the component rope diameter between the loops or end fittings.

(iii) Cable laid grommets, strand laid grommets and endless slings shall have a minimum circumferential length of 96 times their body diameter.

(14) “Safe operating temperatures.” Fiber core wire rope slings of all grades shall be permanently removed from service if they are exposed to temperatures in excess of 200 deg. F (93.33 deg. C). When nonfiber core wire rope slings of any grade are used at temperatures above 400 deg. F (204.44 deg. C) or below minus 60 deg. F (15.55 deg. C), recommendations of the sling manufacturer regarding use at that temperature shall be followed.

(15) “End attachments.”

(i) Welding of end attachments, except covers to thimbles, shall be performed prior to the assembly of the sling.

(ii) All welded end attachments shall not be used unless proof tested by the manufacturer or equivalent entity at twice their rated capacity prior to initial use. The employer shall retain a certificate of proof test, and make it available for examination.

(16) Wire rope slings shall have permanently affixed, legible identification markings stating size, rated capacity for the type(s) of hitch(es) used and the angle upon which it is based, and the number of legs if more than one.

(d) Natural rope, and synthetic fiber.

(1) Employers must not use natural- and synthetic-fiber rope slings with loads in excess of the rated capacities (i.e., working load limits) indicated on the sling by permanently affixed and legible identification markings prescribed by the manufacturer.

(2) All splices in rope slings provided by the employer shall be made in accordance with fiber rope manufacturers recommendations.

- (i) In manila rope, eye splices shall contain at least three full tucks, and short splices shall contain at least six full tucks (three on each side of the center line of the splice).
 - (ii) In layed synthetic fiber rope, eye splices shall contain at least four full tucks, and short splices shall contain at least eight full tucks (four on each side of the center line of the splice).
 - (iii) Strand end tails shall not be trimmed short (flush with the surface of the rope) immediately adjacent to the full tucks. This precaution applies to both eye and short splices and all types of fiber rope. For fiber ropes under 1-inch diameter, the tails shall project at least six rope diameters beyond the last full tuck. For fiber ropes 1-inch diameter and larger, the tails shall project at least 6 inches beyond the last full tuck. In applications where the projecting tails may be objectionable, the tails shall be tapered and spliced into the body of the rope using at least two additional tucks (which will require a tail length of approximately six rope diameters beyond the last full tuck).
 - (iv) For all eye splices, the eye shall be sufficiently large to provide an included angle of not greater than 60 deg. at the splice when the eye is placed over the load or support.
 - (v) Knots shall not be used in lieu of splices.
- (3) "Safe operating temperatures." Natural and synthetic fiber rope slings, except for wet frozen slings, may be used in a temperature range from minus 20 deg. F (-28.88 deg. C) to plus 180 deg. F (82.2 deg. C) without decreasing the working load limit. For operations outside this temperature range and for wet frozen slings, the sling manufacturer's recommendations shall be followed.
- (4) "Splicing." Spliced fiber rope slings shall not be used unless they have been spliced in accordance with the following minimum requirements and in accordance with any additional recommendations of the manufacturer:
- (i) In manila rope, eye splices shall consist of at least three full tucks, and short splices shall consist of at least six full tucks, three on each side of the splice center line.
 - (ii) In synthetic fiber rope, eye splices shall consist of at least four full tucks, and short splices shall consist of at least eight full tucks, four on each side of the center line.
 - (iii) Strand end tails shall not be trimmed flush with the surface of the rope immediately adjacent to the full tucks. This applies to all types of fiber rope and both eye and short splices. For fiber rope under 1 inch (2.54 cm) in diameter, the tail shall project at least six rope diameters beyond the last full tuck. For fiber rope 1 inch (2.54 cm) in diameter and larger, the tail shall project at least 6 inches (15.24 cm) beyond the last full tuck. Where a projecting tail interferes with the use of the sling, the tail shall be tapered and spliced into the body of the rope using at least two additional tucks (which will require a tail length of approximately six rope diameters beyond the last full tuck).
 - (iv) Fiber rope slings shall have a minimum clear length of rope between eye splices equal to 10 times the rope diameter.
 - (v) Knots shall not be used in lieu of splices.
 - (vi) Clamps not designed specifically for fiber ropes shall not be used for splicing.
 - (vii) For all eye splices, the eye shall be of such size to provide an included angle of not greater than 60 degrees at the splice when the eye is placed over the load or support.
- (5) "End attachments." Fiber rope slings shall not be used if end attachments in contact with the rope have sharp edges or projections.
- (6) "Removal from service." Natural and synthetic fiber rope slings shall be immediately removed from service if any of the following conditions are present:
- (i) Abnormal wear.
 - (ii) Powdered fiber between strands.
 - (iii) Broken or cut fibers.
 - (iv) Variations in the size or roundness of strands.
 - (v) Discoloration or rotting.
 - (vi) Distortion of hardware in the sling.
- (7) Employers must use natural- and synthetic-fiber rope slings that have permanently affixed and legible identification markings that state the rated capacity for the type(s) of hitch(es) used and the angle upon which it is based, type of fiber material, and the number of legs if more than one.
- (e) Synthetic webbing (nylon, polyester, and polypropylene).
- (1) The employer shall have each synthetic web sling marked or coded to show:
 - (i) Name or trademark of manufacturer.
 - (ii) Rated capacities for the type of hitch.
 - (iii) Type of material.
 - (2) Rated capacity shall not be exceeded.
 - (3) "Webbing." Synthetic webbing shall be of uniform thickness and width and selvage edges shall not be split from the webbing's width.
 - (4) "Fittings." Fittings shall be:

- (i) Of a minimum breaking strength equal to that of the sling; and
 - (ii) Free of all sharp edges that could in any way damage the webbing.
- (5) "Attachment of end fittings to webbing and formation of eyes." Stitching shall be the only method used to attach end fittings to webbing and to form eyes. The thread shall be in an even pattern and contain a sufficient number of stitches to develop the full breaking strength of the sling.
- (6) "Environmental conditions." When synthetic web slings are used, the following precautions shall be taken:
- (i) Nylon web slings shall not be used where fumes, vapors, sprays, mists or liquids of acids or phenolics are present.
 - (ii) Polyester and polypropylene web slings shall not be used where fumes, vapors, sprays, mists or liquids of caustics are present.
 - (iii) Web slings with aluminum fittings shall not be used where fumes, vapors, sprays, mists or liquids of caustics are present.
- (7) "Safe operating temperatures." Synthetic web slings of polyester and nylon shall not be used at temperatures in excess of 180 deg. F (82.2 deg. C). Polypropylene web slings shall not be used at temperatures in excess of 200 deg. F (93.33 deg. C).
- (8) "Removal from service." Synthetic web slings shall be immediately removed from service if any of the following conditions are present:
- (i) Acid or caustic burns;
 - (ii) Melting or charring of any part of the sling surface;
 - (iii) Snags, punctures, tears or cuts;
 - (iv) Broken or worn stitches; or
 - (v) Distortion of fittings.
- (f) Shackles and hooks.
- (1) Employers must not use shackles with loads in excess of the rated capacities (i.e., working load limits) indicated on the shackle by permanently affixed and legible identification markings prescribed by the manufacturer.
 - (2) The manufacturer's recommendations shall be followed in determining the safe working loads of the various sizes and types of specific and identifiable hooks. All hooks for which no applicable manufacturer's recommendations are available shall be tested to twice the intended safe working load before they are initially put into use. The employer shall maintain a record of the dates and results of such tests.

**TABLE H-1
MAXIMUM ALLOWABLE WEAR AT ANY POINT
OF LINE**

Chain size (inches)	Minimum allowable wear (inch)
1/4"	3/64"
3/8"	5/64"
1/2"	7/64"
5/8"	9/64"
3/4"	5/32"
7/8"	11/64"
1"	3/16"
1 1/8"	7/32"
1 1/4"	1/4"
1 3/8"	9/32"
1 1/2"	5/16"
1 3/4"	11/32"

**TABLE H-2
NUMBER AND SPACING OF U-BOLT
WIRE ROPE CLIPS**

Improved plow steel rope diameter (inches)	Number of clips		Minimum spacing (inches)
	Drop forged	Other material	
1/2"	3	4	3
5/8"	3	4	3¾
3/4"	4	5	4½
7/8"	4	5	5¼
1"	5	6	6
1 1/8"	6	6	6¾
1 1/4"	6	7	7½
1 3/8"	7	7	8¼
1 1/2"	7	8	9



CHAPTER 6:
OSHA 29 CFR 1926, Subpart CC – Cranes and Derricks in Construction

OSHA 1926 Subpart CC – Cranes and Derricks in Construction

Reprinted from Occupational Safety and Health Administration (OSHA) standard. All rights reserved.

This page intentionally left blank



OSHA 1926 Subpart CC – Cranes and Derricks in Construction

Regulations 1926 Subpart CC

- Part Number: 1926
- Part Title: Occupational Safety and Health Standards
- Subpart: CC
- Subpart Title: Cranes and Derricks in Construction
- Applicable Standards: 1926.1401; 1926.1404–1411; 1926.1419–1422; 1926.1424–1925; 1926.1431–1432; Appendix A

§ 1926.1401 Definitions

A/D director (Assembly/Disassembly director) means an individual who meets this subpart’s requirements for an A/D director, irrespective of the person’s formal job title or whether the person is non-management or management personnel.

Articulating crane means a crane whose boom consists of a series of folding, pin connected structural members, typically manipulated to extend or retract by power from hydraulic cylinders.

Assembly/Disassembly means the assembly and/or disassembly of equipment covered under this standard. With regard to tower cranes, “erecting and climbing” replaces the term “assembly,” and “dismantling” replaces the term “disassembly.” Regardless of whether the crane is initially erected to its full height or is climbed in stages, the process of increasing the height of the crane is an erection process.

Assist crane means a crane used to assist in assembling or disassembling a crane.

Attachments means any device that expands the range of tasks that can be done by the equipment. Examples include, but are not limited to: An auger, drill, magnet, pile-driver, and boom-attached personnel platform.

Audible signal means a signal made by a distinct sound or series of sounds. Examples include, but are not limited to, sounds made by a bell, horn, or whistle.

Blocking (also referred to as “cribbing”) is wood or other material used to support equipment or a component and distribute loads to the ground. It is typically used to support lattice boom sections during assembly/ disassembly and under outrigger and stabilizer floats.

Boatswain’s chair means a single-point adjustable suspension scaffold consisting of a seat or sling (which may be incorporated into a full body harness) designed to support one employee in a sitting position.

Bogie means “travel bogie,” which is defined below.

Boom (equipment other than tower crane) means an inclined spar, strut, or other long structural member which supports the upper hoisting tackle on a crane or derrick. Typically, the length and vertical angle of the boom can be varied to achieve increased height or height and reach when lifting loads. Booms can usually be grouped into general categories of hydraulically extendible, cantilevered type, latticed section, cable supported type or articulating type.

Boom (tower cranes): On tower cranes, if the “boom” (i.e., principal horizontal structure) is fixed, it is referred to as a jib; if it is moveable up and down, it is referred to as a boom.

Boom angle indicator means a device which measures the angle of the boom relative to horizontal.

Boom hoist limiting device includes boom hoist disengaging device, boom hoist shut-off, boom hoist disconnect, boom hoist hydraulic relief, boom hoist kick-outs, automatic boom stop device, or derricking limiter. This type of device disengages boom hoist power when the boom reaches a predetermined operating angle. It also sets brakes or closes valves to prevent the boom from lowering after power is disengaged.

Boom length indicator indicates the length of the permanent part of the boom (such as ruled markings on the boom) or, as in some computerized systems, the length of the boom with extensions/ attachments.

Boom stop includes boom stops, (belly straps with struts/standoff), telescoping boom stops, attachment boom stops, and backstops. These devices restrict the boom from moving above a certain maximum angle and toppling over backward.

Boom suspension system means a system of pendants, running ropes, sheaves, and other hardware which supports the boom tip and controls the boom angle.

Builder means the builder/constructor of equipment.

Center of gravity: The center of gravity of any object is the point in the object around which its weight is evenly distributed. If you could put a support under

that point, you could balance the object on the support.

Certified welder means a welder who meets nationally recognized certification requirements applicable to the task being performed.

Climbing means the process in which a tower crane is raised to a new working height, either by adding additional tower sections to the top of the crane (top climbing), or by a system in which the entire crane is raised inside the structure (inside climbing).

Come-a-long means a mechanical device typically consisting of a chain or cable attached at each end that is used to facilitate movement of materials through leverage.

Competent person means one who is capable of identifying existing and predictable hazards in the surroundings or working conditions which are unsanitary, hazardous, or dangerous to employees, and who has authorization to take prompt corrective measures to eliminate them.

Controlled load lowering means lowering a load by means of a mechanical hoist drum device that allows a hoisted load to be lowered with maximum control using the gear train or hydraulic components of the hoist mechanism. Controlled load lowering requires the use of the hoist drive motor, rather than the load hoist brake, to lower the load.

Controlling entity means an employer that is a prime contractor, general contractor, construction manager or any other legal entity which has the overall responsibility for the construction of the project—its planning, quality and completion.

Counterweight means a weight used to supplement the weight of equipment in providing stability for lifting loads by counterbalancing those loads.

Crane/derrick includes all equipment covered by this subpart.

Crawler crane means equipment that has a type of base mounting which incorporates a continuous belt of sprocket driven track.

Crossover points means locations on a wire rope which is spooled on a drum where one layer of rope climbs up on and crosses over the previous layer. This takes place at each flange of the drum as the rope is spooled onto the drum, reaches the flange, and begins to wrap back in the opposite direction.

Dedicated channel means a line of communication assigned by the employer who controls the communication system to only one signal person and crane/derrick or to a coordinated group of cranes/derricks/ signal person(s).

Dedicated pile-driver is a machine that is designed to function exclusively as a pile-driver. These machines typically have the ability to both hoist the mate-

rial that will be pile-driven and to pile-drive that material.

Dedicated spotter (power lines): To be considered a dedicated spotter, the requirements of § 1926.1428 (Signal person qualifications) must be met and his/her sole responsibility is to watch the separation between the power line and the equipment, load line and load (including rigging and lifting accessories), and ensure through communication with the operator that the applicable minimum approach distance is not breached.

Directly under the load means a part or all of an employee is directly beneath the load.

Dismantling includes partial dismantling (such as dismantling to shorten a boom or substitute a different component).

Drum rotation indicator means a device on a crane or hoist which indicates in which direction and at what relative speed a particular hoist drum is turning.

Electrical contact occurs when a person, object, or equipment makes contact or comes in close proximity with an energized conductor or equipment that allows the passage of current.

Employer-made equipment means floating cranes/derricks designed and built by an employer for the employer's own use.

Encroachment is where any part of the crane, load line or load (including rigging and lifting accessories) breaches a minimum clearance distance that this subpart requires to be maintained from a power line.

Equipment means equipment covered by this subpart.

Equipment criteria means instructions, recommendations, limitations and specifications.

Fall protection equipment means guardrail systems, safety net systems, personal fall arrest systems, positioning device systems or fall restraint systems.

Fall restraint system means a fall protection system that prevents the user from falling any distance. The system is comprised of either a body belt or body harness, along with an anchorage, connectors and other necessary equipment. The other components typically include a lanyard, and may also include a lifeline and other devices.

Fall zone means the area (including but not limited to the area directly beneath the load) in which it is reasonably foreseeable that partially or completely suspended materials could fall in the event of an accident.

Flange points are points of contact between rope and drum flange where the rope changes layers.

Floating cranes/derricks means equipment designed by the manufacturer (or employer) for marine use by

permanent attachment to a barge, pontoons, vessel or other means of flotation.

For example means “one example, although there are others.”

Free fall (of the load line) means that only the brake is used to regulate the descent of the load line (the drive mechanism is not used to drive the load down faster or retard its lowering).

Free surface effect is the uncontrolled transverse movement of liquids in compartments which reduce a vessel’s transverse stability.

Hoist means a mechanical device for lifting and lowering loads by winding a line onto or off a drum.

Hoisting is the act of raising, lowering or otherwise moving a load in the air with equipment covered by this standard. As used in this standard, “hoisting” can be done by means other than wire rope/hoist drum equipment.

Include/including means “including, but not limited to.”

Insulating link/device means an insulating device listed, labeled, or accepted by a Nationally Recognized Testing Laboratory in accordance with 29 CFR 1910.7.

Jib stop (also referred to as a jib backstop), is the same type of device as a boom stop but is for a fixed or luffing jib.

Land crane/derrick is equipment not originally designed by the manufacturer for marine use by permanent attachment to barges, pontoons, vessels, or other means of flotation.

List means the angle of inclination about the longitudinal axis of a barge, pontoons, vessel or other means of flotation.

Load refers to the object(s) being hoisted and/or the weight of the object(s); both uses refer to the object(s) and the load-attaching equipment, such as, the load block, ropes, slings, shackles, and any other ancillary attachment.

Load moment (or rated capacity) indicator means a system which aids the equipment operator by sensing (directly or indirectly) the overturning moment on the equipment, i.e., load multiplied by radius. It compares this lifting condition to the equipment’s rated capacity, and indicates to the operator the percentage of capacity at which the equipment is working. Lights, bells, or buzzers may be incorporated as a warning of an approaching overload condition.

Load moment (or rated capacity) limiter means a system which aids the equipment operator by sensing (directly or indirectly) the overturning moment on the equipment, i.e., load multiplied by radius. It compares this lifting condition to the equipment’s rated capacity, and when the rated capacity is reached, it shuts off power to those equipment

functions which can increase the severity of loading on the equipment, e.g., hoisting, telescoping out, or luffing out. Typically, those functions which decrease the severity of loading on the equipment remain operational, e.g., lowering, telescoping in, or luffing in.

Locomotive crane means a crane mounted on a base or car equipped for travel on a railroad track.

Luffing jib limiting device is similar to a boom hoist limiting device, except that it limits the movement of the luffing jib.

Marine hoisted personnel transfer device means a device, such as a “transfer net,” that is designed to protect the employees being hoisted during a marine transfer and to facilitate rapid entry into and exit from the device. Such devices do not include boatswain’s chairs when hoisted by equipment covered by this standard.

Marine worksite means a construction worksite located in, on or above the water.

Mobile crane means a lifting device incorporating a cable suspended latticed boom or hydraulic telescopic boom designed to be moved between operating locations by transport over the road.

Moving point-to-point means the times during which an employee is in the process of going to or from a work station.

Multi-purpose machine means a machine that is designed to be configured in various ways, at least one of which allows it to hoist (by means of a winch or hook) and horizontally move a suspended load. For example, a machine that can rotate and can be configured with removable forks/tongs (for use as a forklift) or with a winch pack, jib (with a hook at the end) or jib used in conjunction with a winch. When configured with the forks/tongs, it is not covered by this subpart. When configured with a winch pack, jib (with a hook at the end) or jib used in conjunction with a winch, it is covered by this subpart.

Nationally recognized accrediting agency is an organization that, due to its independence and expertise, is widely recognized as competent to accredit testing organizations. Examples of such accrediting agencies include, but are not limited to, the National Commission for Certifying Agencies and the American National Standards Institute.

Nonconductive means that, because of the nature and condition of the materials used, and the conditions of use (including environmental conditions and condition of the material), the object in question has the property of not becoming energized (that is, it has high dielectric properties offering a high resistance to the passage of current under the conditions of use).

Operational aids are devices that assist the operator in the safe operation of the crane by providing information or automatically taking control of a crane function. These include, but are not limited to, the devices listed in § 1926.1416 (“listed operational aids”).

Operational controls means levers, switches, pedals and other devices for controlling equipment operation.

Operator means a person who is operating the equipment.

Overhead and gantry cranes includes overhead/bridge cranes, semigantry, cantilever gantry, wall cranes, storage bridge cranes, launching gantry cranes, and similar equipment, irrespective of whether it travels on tracks, wheels, or other means.

Paragraph refers to a paragraph in the same section of this subpart that the word “paragraph” is used, unless otherwise specified.

Pendants includes both wire and bar types. Wire type: A fixed length of wire rope with mechanical fittings at both ends for pinning segments of wire rope together. Bar type: Instead of wire rope, a bar is used. Pendants are typically used in a latticed boom crane system to easily change the length of the boom suspension system without completely changing the rope on the drum when the boom length is increased or decreased.

Personal fall arrest system means a system used to arrest an employee in a fall from a working level. It consists of an anchorage, connectors, a body harness and may include a lanyard, deceleration device, lifeline, or suitable combination of these.

Portal crane is a type of crane consisting of a rotating upperstructure, hoist machinery, and boom mounted on top of a structural gantry which may be fixed in one location or have travel capability. The gantry legs or columns usually have portal openings in between to allow passage of traffic beneath the gantry.

Power lines means electric transmission and distribution lines.

Procedures include, but are not limited to: Instructions, diagrams, recommendations, warnings, specifications, protocols and limitations.

Proximity alarm is a device that provides a warning of proximity to a power line and that has been listed, labeled, or accepted by a Nationally Recognized Testing Laboratory in accordance with 29 CFR 1910.7.

Qualified evaluator (not a third party) means a person employed by the signal person’s employer who has demonstrated that he/she is competent in accurately assessing whether individuals meet the Qualification Requirements in this subpart for a signal person.

Qualified evaluator (third party) means an entity that, due to its independence and expertise, has demonstrated that it is competent in accurately assessing whether individuals meet the Qualification Requirements in this subpart for a signal person.

Qualified person means a person who, by possession of a recognized degree, certificate, or professional standing, or who by extensive knowledge, training and experience, successfully demonstrated the ability to solve/ resolve problems relating to the subject matter, the work, or the project.

Qualified rigger is a rigger who meets the criteria for a qualified person.

Range control limit device is a device that can be set by an equipment operator to limit movement of the boom or jib tip to a plane or multiple planes.

Range control warning device is a device that can be set by an equipment operator to warn that the boom or jib tip is at a plane or multiple planes.

Rated capacity means the maximum working load permitted by the manufacturer under specified working conditions. Such working conditions typically include a specific combination of factors such as equipment configuration, radii, boom length, and other parameters of use.

Rated capacity indicator: See load moment indicator.

Rated capacity limiter: See load moment limiter.

Repetitive pickup points refer to, when operating on a short cycle operation, the rope being used on a single layer and being spooled repetitively over a short portion of the drum.

Running wire rope means a wire rope that moves over sheaves or drums.

Runway means a firm, level surface designed, prepared and designated as a path of travel for the weight and configuration of the crane being used to lift and travel with the crane suspended platform. An existing surface may be used as long as it meets these criteria.

Section means a section of this subpart, unless otherwise specified.

Sideboom crane means a track-type or wheel-type tractor having a boom mounted on the side of the tractor, used for lifting, lowering or transporting a load suspended on the load hook. The boom or hook can be lifted or lowered in a vertical direction only.

Special hazard warnings means warnings of site-specific hazards (for example, proximity of power lines).

Stability (flotation device) means the tendency of a barge, pontoons, vessel or other means of flotation to return to an upright position after having been inclined by an external force.

Standard Method means the protocol in Appendix A of this subpart for hand signals.

Such as means “such as, but not limited to.”

Superstructure: See Upperworks.

Tagline means a rope (usually fiber) attached to a lifted load for purposes of controlling load spinning and pendular motions or used to stabilize a bucket or magnet during material handling operations.

Tender means an individual responsible for monitoring and communicating with a diver.

Tilt up or tilt down operation means raising/lowering a load from the horizontal to vertical or vertical to horizontal.

Tower crane is a type of lifting structure which utilizes a vertical mast or tower to support a working boom (jib) in an elevated position. Loads are suspended from the working boom. While the working boom may be of the fixed type (horizontal or angled) or have luffing capability, it can always rotate to swing loads, either by rotating on the top of the tower (top slewing) or by the rotation of the tower (bottom slewing). The tower base may be fixed in one location or ballasted and moveable between locations. Mobile cranes that are configured with luffing jib and/or tower attachments are not considered tower cranes under this section.

Travel bogie (tower cranes) is an assembly of two or more axles arranged to permit vertical wheel displacement and equalize the loading on the wheels.

Trim means angle of inclination about the transverse axis of a barge, pontoons, vessel or other means of floatation.

Two blocking means a condition in which a component that is uppermost on the hoist line such as the load block, hook block, overhaul ball, or similar component, comes in contact with the boom tip, fixed upper block or similar component. This binds the system and continued application of power can cause failure of the hoist rope or other component.

Unavailable procedures means procedures that are no longer available from the manufacturer, or have never been available, from the manufacturer.

Upperstructure: See Upperworks.

Upperworks means the revolving frame of equipment on which the operating machinery (and many cases the engine) are mounted along with the operator's cab. The counterweight is typically supported on the rear of the upperstructure and the boom or other front end attachment is mounted on the front.

Up to means “up to and including.”

Wire rope means a flexible rope constructed by laying steel wires into various patterns of multi-wired strands around a core system to produce a helically wound rope.

§ 1926.1404 Assembly/Disassembly—general requirements (applies to all assembly and disassembly operations)

(a) *Supervision—competent-qualified person.*

- (1) Assembly/disassembly must be directed by a person who meets the criteria for both a competent person and a qualified person, or by a competent person who is assisted by one or more qualified persons (“A/D director”).
- (2) Where the assembly/disassembly is being performed by only one person, that person must meet the criteria for both a competent person and a qualified person. For purposes of this standard, that person is considered the A/D director.

(b) *Knowledge of procedures.* The A/D director must understand the applicable assembly/disassembly procedures.

(c) *Review of procedures.* The A/D director must review the applicable assembly/disassembly procedures immediately prior to the commencement of assembly/disassembly unless the A/D director understands the procedures and has applied them to the same type and configuration of equipment (including accessories, if any).

(d) *Crew instructions.*

- (1) Before commencing assembly/disassembly operations, the A/D director must ensure that the crew members understand all of the following:
 - (i) Their tasks.
 - (ii) The hazards associated with their tasks.
 - (iii) The hazardous positions/locations that they need to avoid.
- (2) During assembly/disassembly operations, before a crew member takes on a different task, or when adding new personnel during the operations, the requirements in paragraphs (d)(1)(i) through (d)(1)(iii) of this section must be met.

(e) *Protecting assembly/disassembly crew members out of operator view.*

- (1) Before a crew member goes to a location that is out of view of the operator and is either in, on, or under the equipment, or near the equipment (or load) where the crew member could be injured by movement of the equipment (or load), the crew member must inform the operator that he/she is going to that location.
- (2) Where the operator knows that a crew member went to a location covered by paragraph (e) (1) of this section, the operator must not move any part of the equipment (or load) until the operator is informed in accordance with a

pre-arranged system of communication that the crew member is in a safe position.

(f) *Working under the boom, jib or other components.*

- (1) When pins (or similar devices) are being removed, employees must not be under the boom, jib, or other components, except where the requirements of paragraph (f)(2) of this section are met.
- (2) *Exception.* Where the employer demonstrates that site constraints require one or more employees to be under the boom, jib, or other components when pins (or similar devices) are being removed, the A/D director must implement procedures that minimize the risk of unintended dangerous movement and minimize the duration and extent of exposure under the boom. (See Non-mandatory Appendix B of this subpart for an example.)

(g) *Capacity limits.* During all phases of assembly/disassembly, rated capacity limits for loads imposed on the equipment, equipment components (including rigging), lifting lugs and equipment accessories, must not be exceeded for the equipment being assembled/disassembled.

(h) *Addressing specific hazards.* The A/D director supervising the assembly/ disassembly operation must address the hazards associated with the operation, which include:

- (1) Site and ground bearing conditions. Site and ground conditions must be adequate for safe assembly/ disassembly operations and to support the equipment during assembly/ disassembly (*see* § 1926.1402 for ground condition requirements).
- (2) Blocking material. The size, amount, condition and method of stacking the blocking must be sufficient to sustain the loads and maintain stability.
- (3) Proper location of blocking. When used to support lattice booms or components, blocking must be appropriately placed to:
 - (i) Protect the structural integrity of the equipment, and
 - (ii) Prevent dangerous movement and collapse.
- (4) Verifying assist crane loads. When using an assist crane, the loads that will be imposed on the assist crane at each phase of assembly/disassembly must be verified in accordance with § 1926.1417(o)(3) before assembly/ disassembly begins.
- (5) Boom and jib pick points. The point(s) of attachment of rigging to a boom (or boom sections or jib or jib sections) must be suitable for preventing structural damage and facilitating safe handling of these components.

(6) *Center of gravity.*

- (i) The center of gravity of the load must be identified if that is necessary for the method used for maintaining stability.
- (ii) Where there is insufficient information to accurately identify the center of gravity, measures designed to prevent unintended dangerous movement resulting from an inaccurate identification of the center of gravity must be used. (*See* Non-mandatory Appendix B of this subpart for an example.)

(7) *Stability upon pin removal.* The boom sections, boom suspension systems (such as gantry A-frames and jib struts), and components must be rigged or supported to maintain stability upon the removal of the pins.

(8) *Snagging.* Suspension ropes and pendants must not be allowed to catch on the boom or jib connection pins or cotter pins (including keepers and locking pins).

(9) *Struck by counterweights.* The potential for unintended movement from inadequately supported counterweights and from hoisting counterweights.

(10) *Boom hoist brake failure.* Each time reliance is to be placed on the boom hoist brake to prevent boom movement during assembly/ disassembly, the brake must be tested prior to such reliance to determine if it is sufficient to prevent boom movement. If it is not sufficient, a boom hoist pawl, other locking device/back-up braking device, or another method of preventing dangerous movement of the boom (such as blocking or using an assist crane) from a boom hoist brake failure must be used.

(11) *Loss of backward stability.* Backward stability before swinging the upperworks, travel, and when attaching or removing equipment components.

(12) *Wind speed and weather.* The effect of wind speed and weather on the equipment.

(i) *[Reserved.]*

(j) *Cantilevered boom sections.* Manufacturer limitations on the maximum amount of boom supported only by cantilevering must not be exceeded. Where these are unavailable, a registered professional engineer familiar with the type of equipment involved must determine in writing this limitation, which must not be exceeded.

(k) *Weight of components.* The weight of each of the components must be readily available.

(l) *[Reserved.]*

(m) *Components and configuration.*

- (1) The selection of components, and configuration of the equipment, that affect the capacity or safe operation of the equipment must be in accordance with:
- (i) Manufacturer instructions, prohibitions, limitations, and specifications. Where these are unavailable, a registered professional engineer familiar with the type of equipment involved must approve, in writing, the selection and configuration of components; or
 - (ii) Approved modifications that meet the requirements of § 1926.1434 (Equipment modifications).
- (2) *Post-assembly inspection.* Upon completion of assembly, the equipment must be inspected to ensure compliance with paragraph (m)(1) of this section (*see* § 1926.1412(c) for post-assembly inspection requirements).
- (n) *[Reserved.]*
- (o) *Shipping pins.* Reusable shipping pins, straps, links, and similar equipment must be removed. Once they are removed they must either be stowed or otherwise stored so that they do not present a falling object hazard.
- (p) *Pile driving.* Equipment used for pile driving must not have a jib attached during pile driving operations.
- (q) *Outriggers and Stabilizers.* When the load to be handled and the operating radius require the use of outriggers or stabilizers, or at any time when outriggers or stabilizers are used, all of the following requirements must be met (except as otherwise indicated):
- (1) The outriggers or stabilizers must be either fully extended or, if manufacturer procedures permit, deployed as specified in the load chart.
 - (2) The outriggers must be set to remove the equipment weight from the wheels, except for locomotive cranes (*see* paragraph (q)(6) of this section for use of outriggers on locomotive cranes). This provision does not apply to stabilizers.
 - (3) When outrigger floats are used, they must be attached to the outriggers. When stabilizer floats are used, they must be attached to the stabilizers.
 - (4) Each outrigger or stabilizer must be visible to the operator or to a signal person during extension and setting.
 - (5) Outrigger and stabilizer blocking must:
 - (i) Meet the requirements in paragraphs (h)(2) and (h)(3) of this section.
 - (ii) Be placed only under the outrigger or stabilizer float/pad of the jack or, where the outrigger or stabilizer is designed without a jack, under the outer bearing surface of the extended outrigger or stabilizer beam.
- (6) For locomotive cranes, when using outriggers or stabilizers to handle loads, the manufacturer's procedures must be followed. When lifting loads without using outriggers or stabilizers, the manufacturer's procedures must be met regarding truck wedges or screws.
- (r) *Rigging.* In addition to following the requirements in 29 CFR 1926.251 and other requirements in this and other standards applicable to rigging, when rigging is used for assembly/ disassembly, the employer must ensure that:
- (1) The rigging work is done by a qualified rigger.
 - (2) Synthetic slings are protected from: Abrasive, sharp or acute edges, and configurations that could cause a reduction of the sling's rated capacity, such as distortion or localized compression. **Note:** Requirements for the protection of wire rope slings are contained in 29 CFR 1926.251(c)(9).
 - (3) When synthetic slings are used, the synthetic sling manufacturer's instructions, limitations, specifications and recommendations must be followed.

§ 1926.1405 Disassembly—additional requirements for dismantling of booms and jibs (applies to both the use of manufacturer procedures and employer procedures)

Dismantling (including dismantling for changing the length of) booms and jibs.

- (a) None of the pins in the pendants are to be removed (partly or completely) when the pendants are in tension.
- (b) None of the pins (top or bottom) on boom sections located between the pendant attachment points and the crane/derrick body are to be removed (partly or completely) when the pendants are in tension.
- (c) None of the pins (top or bottom) on boom sections located between the uppermost boom section and the crane/ derrick body are to be removed (partly or completely) when the boom is being supported by the uppermost boom section resting on the ground (or other support).
- (d) None of the top pins on boom sections located on the cantilevered portion of the boom being removed (the portion being removed ahead of the pendant attachment points) are to be removed (partly or completely) until the cantilevered section to be removed is fully supported.

§ 1926.1406 Assembly/Disassembly— employer procedures—general requirements

- (a) When using employer procedures instead of manufacturer procedures for assembly/disassembly, the employer must ensure that the procedures:
- (1) Prevent unintended dangerous movement, and prevent collapse, of any part of the equipment.
 - (2) Provide adequate support and stability of all parts of the equipment.
 - (3) Position employees involved in the assembly/disassembly operation so that their exposure to unintended movement or collapse of part or all of the equipment is minimized.
- (b) *Qualified person.* Employer procedures must be developed by a qualified person.

§ 1926.1407 Power line safety (up to 350 kV)—assembly and disassembly.

- (a) Before assembling or disassembling equipment, the employer must determine if any part of the equipment, load line, or load (including rigging and lifting accessories) could get, in the direction or area of assembly/disassembly, closer than 20 feet to a power line during the assembly/disassembly process. If so, the employer must meet the requirements in Option (1), Option (2), or Option (3) of this section, as follows:
- (1) *Option (1)—Deenergize and ground.* Confirm from the utility owner/operator that the power line has been deenergized and visibly grounded at the worksite.
 - (2) *Option (2)—20 foot clearance.* Ensure that no part of the equipment, load line or load (including rigging and lifting accessories), gets closer than 20 feet to the power line by implementing the measures specified in paragraph (b) of this section.
 - (3) *Option (3)—Table A clearance.*
 - (i) Determine the line's voltage and the minimum clearance distance permitted under Table A (see § 1926.1408).
 - (ii) Determine if any part of the equipment, load line, or load (including rigging and lifting accessories), could get closer than the minimum clearance distance to the power line permitted under Table A (see § 1926.1408). If so, then the employer must follow the requirements in paragraph (b) of this section to ensure that no part of the equipment, load line, or load (including rigging and lifting accessories), gets closer to the line than the minimum clearance distance.
- (b) *Preventing encroachment/ electrocution.* Where encroachment precautions are required under

Option (2), or Option (3) of this section, all of the following requirements must be met:

- (1) Conduct a planning meeting with the Assembly/Disassembly director (A/D director), operator, assembly/disassembly crew and the other workers who will be in the assembly/disassembly area to review the location of the power line(s) and the steps that will be implemented to prevent encroachment/electrocution.
- (2) If tag lines are used, they must be nonconductive.
- (3) At least one of the following additional measures must be in place. The measure selected from this list must be effective in preventing encroachment.

The additional measures are:

- (i) Use a dedicated spotter who is in continuous contact with the equipment operator. The dedicated spotter must:
 - (A) Be equipped with a visual aid to assist in identifying the minimum clearance distance. Examples of a visual aid include, but are not limited to: A clearly visible line painted on the ground; a clearly visible line of stanchions; a set of clearly visible line-of-sight landmarks (such as a fence post behind the dedicated spotter and a building corner ahead of the dedicated spotter).
 - (B) Be positioned to effectively gauge the clearance distance.
 - (C) Where necessary, use equipment that enables the dedicated spotter to communicate directly with the operator.
 - (D) Give timely information to the operator so that the required clearance distance can be maintained.
 - (ii) A proximity alarm set to give the operator sufficient warning to prevent encroachment.
 - (iii) A device that automatically warns the operator when to stop movement, such as a range control warning device. Such a device must be set to give the operator sufficient warning to prevent encroachment.
 - (iv) A device that automatically limits range of movement, set to prevent encroachment.
 - (v) An elevated warning line, barricade, or line of signs, in view of the operator, equipped with flags or similar high-visibility markings.
- (c) *Assembly/disassembly below power lines prohibited.* No part of a crane/derrick, load line, or load (including rigging and lifting accessories), whether partially or fully assembled, is allowed below a power line unless the employer has confirmed that

the utility owner/operator has deenergized and (at the worksite) visibly grounded the power line.

- (d) *Assembly/disassembly inside Table A clearance prohibited.* No part of a crane/derrick, load line, or load (including rigging and lifting accessories), whether partially or fully assembled, is allowed closer than the minimum approach distance under Table A (see § 1926.1408) to a power line unless the employer has confirmed that the utility owner/operator has deenergized and (at the worksite) visibly grounded the power line.
- (e) *Voltage information.* Where Option (3) of this section is used, the utility owner/operator of the power lines must provide the requested voltage information within two working days of the employer's request.
- (f) *Power lines presumed energized.* The employer must assume that all power lines are energized unless the utility owner/operator confirms that the power line has been and continues to be deenergized and visibly grounded at the worksite.
- (g) *Posting of electrocution warnings.* There must be at least one electrocution hazard warning conspicuously posted in the cab so that it is in view of the operator and (except for overhead gantry and tower cranes) at least two on the outside of the equipment.

§ 1926.1408 Power line safety (up to 350 kV)—equipment operations

- (a) *Hazard assessments and precautions inside the work zone.* Before beginning equipment operations, the employer must:
 - (1) *Identify the work zone by either:*
 - (i) Demarcating boundaries (such as with flags, or a device such as a range limit device or range control warning device) and prohibiting the operator from operating the equipment past those boundaries, or
 - (ii) Defining the work zone as the area 360 degrees around the equipment, up to the equipment's maximum working radius.
 - (2) Determine if any part of the equipment, load line or load (including rigging and lifting accessories), if operated up to the equipment's maximum working radius in the work zone, could get closer than 20 feet to a power line. If so, the employer must meet the requirements in Option (1), Option (2), or Option (3) of this section, as follows:
 - (i) *Option (1)—Deenergize and ground.* Confirm from the utility owner/operator that the power line has been deenergized and visibly grounded at the worksite.
 - (ii) *Option (2)—20 foot clearance.* Ensure that no part of the equipment, load line, or load (including rigging and lifting accessories),

gets closer than 20 feet to the power line by implementing the measures specified in paragraph (b) of this section.

- (iii) *Option (3)—Table A clearance.*
 - (A) Determine the line's voltage and the minimum approach distance permitted under Table A (see § 1926.1408).
 - (B) Determine if any part of the equipment, load line or load (including rigging and lifting accessories), while operating up to the equipment's maximum working radius in the work zone, could get closer than the minimum approach distance of the power line permitted under Table A (see § 1926.1408). If so, then the employer must follow the requirements in paragraph (b) of this section to ensure that no part of the equipment, load line, or load (including rigging and lifting accessories), gets closer to the line than the minimum approach distance.
- (b) *Preventing encroachment/electrocution.* Where encroachment precautions are required under Option (2) or Option (3) of this section, all of the following requirements must be met:
 - (1) Conduct a planning meeting with the operator and the other workers who will be in the area of the equipment or load to review the location of the power line(s), and the steps that will be implemented to prevent encroachment/electrocution.
 - (2) If tag lines are used, they must be non-conductive.
 - (3) Erect and maintain an elevated warning line, barricade, or line of signs, in view of the operator, equipped with flags or similar high-visibility markings, at 20 feet from the power line (if using Option (2) of this section) or at the minimum approach distance under Table A (see § 1926.1408) (if using Option (3) of this section). If the operator is unable to see the elevated warning line, a dedicated spotter must be used as described in § 1926.1408(b)(4)(ii) in addition to implementing one of the measures described in §§ 1926.1408(b)(4)(i), (iii), (iv) and (v).
 - (4) Implement at least one of the following measures:
 - (i) A proximity alarm set to give the operator sufficient warning to prevent encroachment.
 - (ii) A dedicated spotter who is in continuous contact with the operator. Where this measure is selected, the dedicated spotter must:
 - (A) Be equipped with a visual aid to assist in identifying the minimum clearance distance. Examples of a visual aid include,

but are not limited to: A clearly visible line painted on the ground; a clearly visible line of stanchions; a set of clearly visible line-of-sight landmarks (such as a fence post behind the dedicated spotter and a building corner ahead of the dedicated spotter).

- (B) Be positioned to effectively gauge the clearance distance.
 - (C) Where necessary, use equipment that enables the dedicated spotter to communicate directly with the operator.
 - (D) Give timely information to the operator so that the required clearance distance can be maintained.
- (iii) A device that automatically warns the operator when to stop movement, such as a range control warning device. Such a device must be set to give the operator sufficient warning to prevent encroachment.
 - (iv) A device that automatically limits range of movement, set to prevent encroachment.
 - (v) An insulating link/device, as defined in § 1926.1401, installed at a point between the end of the load line (or below) and the load.
- (5) The requirements of paragraph (b)(4) of this section do not apply to work covered by subpart V of this part.
- (c) *Voltage information.* Where Option (3) of this section is used, the utility owner/operator of the power lines must provide the requested voltage information within two working days of the employer's request.
- (d) *Operations below power lines.*
- (1) No part of the equipment, load line, or load (including rigging and lifting accessories) is allowed below a power line unless the employer has confirmed that the utility owner/operator has deenergized and (at the worksite) visibly grounded the power line, except where one of the exceptions in paragraph (d)(2) of this section applies.
 - (2) *Exceptions.* Paragraph (d)(1) of this section is inapplicable where the employer demonstrates that one of the following applies:
 - (i) The work is covered by subpart V of this part.
 - (ii) For equipment with non-extensible booms: The uppermost part of the equipment, with the boom at true vertical, would be more than 20 feet below the plane of the power line or more than the Table A of this section minimum clearance distance below the plane of the power line.
 - (iii) For equipment with articulating or extensible booms: The uppermost part of the equipment, with the boom in the fully extended position, at true vertical, would be more than 20 feet below the plane of the power line or more than the Table A of this section minimum clearance distance below the plane of the power line.
 - (iv) The employer demonstrates that compliance with paragraph (d)(1) of this section is infeasible and meets the requirements of § 1926.1410.
- (e) *Power lines presumed energized.* The employer must assume that all power lines are energized unless the utility owner/operator confirms that the power line has been and continues to be deenergized and visibly grounded at the worksite.
- (f) When working near transmitter/ communication towers where the equipment is close enough for an electrical charge to be induced in the equipment or materials being handled, the transmitter must be deenergized or the following precautions must be taken:
- (1) The equipment must be provided with an electrical ground.
 - (2) If tag lines are used, they must be non-conductive.
- (g) *Training.*
- (1) The employer must train each operator and crew member assigned to work with the equipment on all of the following:
 - (i) The procedures to be followed in the event of electrical contact with a power line. Such training must include:
 - (A) Information regarding the danger of electrocution from the operator simultaneously touching the equipment and the ground.
 - (B) The importance to the operator's safety of remaining inside the cab except where there is an imminent danger of fire, explosion, or other emergency that necessitates leaving the cab.
 - (C) The safest means of evacuating from equipment that may be energized.
 - (D) The danger of the potentially energized zone around the equipment (step potential).
 - (E) The need for crew in the area to avoid approaching or touching the equipment and the load.
 - (F) Safe clearance distance from power lines.
 - (ii) Power lines are presumed to be energized unless the utility owner/operator confirms that the power line has been and continues

to be deenergized and visibly grounded at the worksite

- (iii) Power lines are presumed to be uninsulated unless the utility owner/operator or a registered engineer who is a qualified person with respect to electrical power transmission and distribution confirms that a line is insulated.
 - (iv) The limitations of an insulating link/device, proximity alarm, and range control (and similar) device, if used.
 - (v) The procedures to be followed to properly ground equipment and the limitations of grounding.
- (2) Employees working as dedicated spotters must be trained to enable them to effectively perform their task, including training on the applicable requirements of this section.
- (3) Training under this section must be administered in accordance with § 1926.1430(g).
- (h) Devices originally designed by the manufacturer for use as: A safety device (*see* § 1926.1415), operational aid, or a means to prevent power line contact or electrocution, when used to comply with this section, must meet the manufacturer’s procedures for use and conditions of use.

TABLE A—MINIMUM CLEARANCE DISTANCES

Voltage (nominal, kV, alternating current)	Minimum clearance distance (feet)
up to 50.....	10
over 50 to 200.....	15
over 200 to 350.....	20
over 350 to 500.....	25
over 500 to 750.....	35
over 750 to 1,000.....	45
over 1,000.....	(as established by the utility owner/operator or registered professional engineer who is a qualified person with respect to electrical power and distribution.)

Note: The value that follows “to” is up to and includes that value. For example, over 50 to 200 means up to and including 200kV.

§ 1926.1409 Power line safety (over 350 kV)

The requirements of § 1926.1407 and § 1926.1408 apply to power lines over 350 kV except:

- (a) For power lines at or below 1000 kV, wherever the distance “20 feet” is specified, the distance “50 feet” must be substituted; and
- (b) For power lines over 1000 kV, the minimum clearance distance must be established by the utility owner/ operator or registered professional engineer who is a qualified person with respect to electrical power transmission and distribution.

§ 1926.1410 Power line safety (all voltages)—equipment operations closer than the Table A zone

Equipment operations in which any part of the equipment, load line, or load (including rigging and lifting accessories) is closer than the minimum approach distance under Table A of § 1926.1408 to an energized power line is prohibited, except where the employer demonstrates that all of the following requirements are met:

- (a) The employer determines that it is infeasible to do the work without breaching the minimum approach distance under Table A of § 1926.1408.
- (b) The employer determines that, after consultation with the utility owner/operator, it is infeasible to deenergize and ground the power line or relocate the power line.

(c) *Minimum clearance distance.*

- (1) The power line owner/operator or registered professional engineer who is a qualified person with respect to electrical power transmission and distribution determines the minimum clearance distance that must be maintained to prevent electrical contact in light of the on-site conditions. The factors that must be considered in making this determination include, but are not limited to: Conditions affecting atmospheric conductivity; time necessary to bring the equipment, load line, and load (including rigging and lifting accessories) to a complete stop; wind conditions; degree of sway in the power line; lighting conditions, and other conditions affecting the ability to prevent electrical contact.

- (2) Paragraph (c)(1) of this section does not apply to work covered by subpart V of this part; instead, for such work, the minimum clearance distances specified in § 1926.950 Table V-1 apply. Employers engaged in subpart V work are permitted to work closer than the distances in § 1926.950 Table V-1 where both the requirements of this section and § 1926.952(c)(3)(i) or (ii) are met.

- (d) A planning meeting with the employer and utility owner/operator (or registered professional engineer who is a qualified person with respect to electrical power transmission and distribution) is held to determine the procedures that will be followed to prevent electrical contact and electrocution. At a minimum these procedures must include:

- (1) If the power line is equipped with a device that automatically reenergizes the circuit in the event of a power line contact, before the work begins, the automatic reclosing feature of the circuit interrupting device must be made inoperative if the design of the device permits.

- (2) A dedicated spotter who is in continuous contact with the operator. The dedicated spotter must:
- (i) Be equipped with a visual aid to assist in identifying the minimum clearance distance. Examples of a visual aid include, but are not limited to: A line painted on the ground; a clearly visible line of stanchions; a set of clearly visible line-of-sight landmarks (such as a fence post behind the dedicated spotter and a building corner ahead of the dedicated spotter).
 - (ii) Be positioned to effectively gauge the clearance distance.
 - (iii) Where necessary, use equipment that enables the dedicated spotter to communicate directly with the operator.
 - (iv) Give timely information to the operator so that the required clearance distance can be maintained.
- (3) An elevated warning line, or barricade (not attached to the crane), in view of the operator (either directly or through video equipment), equipped with flags or similar high-visibility markings, to prevent electrical contact. However, this provision does not apply to work covered by subpart V of this part.
- (4) *Insulating link/device.*
- (i) An insulating link/device installed at a point between the end of the load line (or below) and the load.
 - (ii) For work covered by subpart V of this part, the requirement in paragraph (d)(4)(i) of this section applies only when working inside the § 1926.950 Table V-1 clearance distances.
 - (iii) For work covered by subpart V of this part involving operations where use of an insulating link/device is infeasible, the requirements of § 1910.269(p)(4)(iii)(B) or (C) may be substituted for the requirement in (d)(4)(i) of this section.
 - (iv) Until November 8, 2011, the following procedure may be substituted for the requirement in paragraph (d)(4)(i) of this section: All employees, excluding equipment operators located on the equipment, who may come in contact with the equipment, the load line, or the load must be insulated or guarded from the equipment, the load line, and the load. Insulating gloves rated for the voltage involved are adequate insulation for the purposes of this paragraph.
 - (v) Until November 8, 2013, the following procedure may be substituted for the requirement in (d)(4)(i) of this section:
 - (A) The employer must use a link/ device manufactured on or before November 8, 2011, that meets the definition of an insulating link/device, except that it has not been approved by a Nationally Recognized Testing Laboratory, and that is maintained and used in accordance with manufacturer requirements and recommendations, and is installed at a point between the end of the load line (or below) and the load; and
 - (B) All employees, excluding equipment operators located on the equipment, who may come in contact with the equipment, the load line, or the load must be insulated or guarded from the equipment, the load line, and the load through an additional means other than the device described in paragraph (d)(4)(v)(A) of this section. Insulating gloves rated for the voltage involved are adequate additional means of protection for the purposes of this paragraph.
- (5) Nonconductive rigging if the rigging may be within the Table A of § 1926.1408 distance during the operation.
 - (6) If the equipment is equipped with a device that automatically limits range of movement, it must be used and set to prevent any part of the equipment, load line, or load (including rigging and lifting accessories) from breaching the minimum approach distance established under paragraph (c) of this section.
 - (7) If a tag line is used, it must be of the nonconductive type.
 - (8) Barricades forming a perimeter at least 10 feet away from the equipment to prevent unauthorized personnel from entering the work area. In areas where obstacles prevent the barricade from being at least 10 feet away, the barricade must be as far from the equipment as feasible.
 - (9) Workers other than the operator must be prohibited from touching the load line above the insulating link/ device and crane. Operators remotely operating the equipment from the ground must use either wireless controls that isolate the operator from the equipment or insulating mats that insulate the operator from the ground.
 - (10) Only personnel essential to the operation are permitted to be in the area of the crane and load.
 - (11) The equipment must be properly grounded.
 - (12) Insulating line hose or cover-up must be installed by the utility owner/ operator except where such devices are unavailable for the line voltages involved.

- (e) The procedures developed to comply with paragraph (d) of this section are documented and immediately available on-site.
- (f) The equipment user and utility owner/operator (or registered professional engineer) meet with the equipment operator and the other workers who will be in the area of the equipment or load to review the procedures that will be implemented to prevent breaching the minimum approach distance established in paragraph (c) of this section and prevent electrocution.
- (g) The procedures developed to comply with paragraph (d) of this section are implemented.
- (h) The utility owner/operator (or registered professional engineer) and all employers of employees involved in the work must identify one person who will direct the implementation of the procedures. The person identified in accordance with this paragraph must direct the implementation of the procedures and must have the authority to stop work at any time to ensure safety.
- (i) *[Reserved.]*
- (j) If a problem occurs implementing the procedures being used to comply with paragraph (d) of this section, or indicating that those procedures are inadequate to prevent electrocution, the employer must safely stop operations and either develop new procedures to comply with paragraph (d) of this section or have the utility owner/operator deenergize and visibly ground or relocate the power line before resuming work.
- (k) Devices originally designed by the manufacturer for use as a safety device (*see* § 1926.1415), operational aid, or a means to prevent power line contact or electrocution, when used to comply with this section, must comply with the manufacturer's procedures for use and conditions of use.
- (l) *[Reserved.]*
- (m) The employer must train each operator and crew member assigned to work with the equipment in accordance with § 1926.1408(g).

§ 1926.1411 Power line safety—while traveling under or near power lines with no load

- (a) This section establishes procedures and criteria that must be met for equipment traveling under or near a power line on a construction site with no load. Equipment traveling on a construction site with a load is governed by §§ 1926.1408, 1926.1409 or 1926.1410, whichever is appropriate, and § 1926.1417(u).
- (b) The employer must ensure that:

- (1) The boom/mast and boom/mast support system are lowered sufficiently to meet the requirements of this paragraph.
- (2) The clearances specified in Table T of this section are maintained.
- (3) The effects of speed and terrain on equipment movement (including movement of the boom/mast) are considered so that those effects do not cause the minimum clearance distances specified in Table T of this section to be breached.
- (4) Dedicated spotter. If any part of the equipment while traveling will get closer than 20 feet to the power line, the employer must ensure that a dedicated spotter who is in continuous contact with the driver/operator is used. The dedicated spotter must:
 - (i) Be positioned to effectively gauge the clearance distance.
 - (ii) Where necessary, use equipment that enables the dedicated spotter to communicate directly with the operator.
 - (iii) Give timely information to the operator so that the required clearance distance can be maintained.
- (5) Additional precautions for traveling in poor visibility. When traveling at night, or in conditions of poor visibility, in addition to the measures specified in paragraphs (b)(1) through (4) of this section, the employer must ensure that:
 - (i) The power lines are illuminated or another means of identifying the location of the lines is used.
 - (ii) A safe path of travel is identified and used.

TABLE T—MINIMUM CLEARANCE DISTANCES WHILE TRAVELING WITH NO LOAD

Voltage (nominal, kV, alternating current)	Minimum clearance distance (feet)
up to 0.75.....	4
over .75 to 50.....	6
over 50 to 345.....	10
over 345 to 750.....	16
over 750 to 1,000.....	20
over 1,000	(as established by the utility owner/operator or registered professional engineer who is a qualified person with respect to electrical power and distribution.)

§ 1926.1424 Work area control

- (a) *Swing radius hazards.*
 - (1) The requirements in paragraph (a)(2) of this section apply where there are accessible areas in which the equipment's rotating superstructure

(whether permanently or temporarily mounted) poses a reasonably foreseeable risk of:

- (i) Striking and injuring an employee; or
- (ii) Pinching/crushing an employee against another part of the equipment or another object.

(2) To prevent employees from entering these hazard areas, the employer must:

- (i) Train each employee assigned to work on or near the equipment (“authorized personnel”) in how to recognize struck-by and pinch/crush hazard areas posed by the rotating superstructure.
- (ii) Erect and maintain control lines, warning lines, railings or similar barriers to mark the boundaries of the hazard areas. *Exception:* When the employer can demonstrate that it is neither feasible to erect such barriers on the ground nor on the equipment, the hazard areas must be clearly marked by a combination of warning signs (such as “Danger—Swing/Crush Zone”) and high visibility markings on the equipment that identify the hazard areas. In addition, the employer must train each employee to understand what these markings signify.

(3) *Protecting employees in the hazard area.*

- (i) Before an employee goes to a location in the hazard area that is out of view of the operator, the employee (or someone instructed by the employee) must ensure that the operator is informed that he/she is going to that location.
- (ii) Where the operator knows that an employee went to a location covered by paragraph (a) (1) of this section, the operator must not rotate the superstructure until the operator is informed in accordance with a pre-arranged system of communication that the employee is in a safe position.

(b) Where any part of a crane/derrick is within the working radius of another crane/derrick, the controlling entity must institute a system to coordinate operations. If there is no controlling entity, the employer (if there is only one employer operating the multiple pieces of equipment), or employers, must institute such a system.

§ 1926.1425 Keeping clear of the load

- (a) Where available, hoisting routes that minimize the exposure of employees to hoisted loads must be used, to the extent consistent with public safety.
- (b) While the operator is not moving a suspended load, no employee must be within the fall zone, except for employees:
 - (1) Engaged in hooking, unhooking or guiding a load;

(2) Engaged in the initial attachment of the load to a component or structure; or

(3) Operating a concrete hopper or concrete bucket.

(c) When employees are engaged in hooking, unhooking, or guiding the load, or in the initial connection of a load to a component or structure and are within the fall zone, all of the following criteria must be met:

- (1) The materials being hoisted must be rigged to prevent unintentional displacement.
- (2) Hooks with self-closing latches or their equivalent must be used. Exception: “J” hooks are permitted to be used for setting wooden trusses.
- (3) The materials must be rigged by a qualified rigger.

(d) *Receiving a load.* Only employees needed to receive a load are permitted to be within the fall zone when a load is being landed.

(e) During a tilt-up or tilt-down operation:

- (1) No employee must be directly under the load.
- (2) Only employees essential to the operation are permitted in the fall zone (but not directly under the load). An employee is essential to the operation if the employee is conducting one of the following operations and the employer can demonstrate it is infeasible for the employee to perform that operation from outside the fall zone: (1) Physically guide the load; (2) closely monitor and give instructions regarding the load’s movement; or (3) either detach it from or initially attach it to another component or structure (such as, but not limited to, making an initial connection or installing bracing).

Note: Boom free fall is prohibited when an employee is in the fall zone of the boom or load, and load line free fall is prohibited when an employee is directly under the load; see § 1926.1426.

§ 1926.1431 Hoisting personnel

The requirements of this section are supplemental to the other requirements in this subpart and apply when one or more employees are hoisted.

(a) The use of equipment to hoist employees is prohibited except where the employer demonstrates that the erection, use, and dismantling of conventional means of reaching the work area, such as a personnel hoist, ladder, stairway, aerial lift, elevating work platform, or scaffold, would be more hazardous, or is not possible because of the project’s structural design or worksite conditions. This paragraph does not apply to work covered by subpart R (Steel Erection) of this part.

(b) *Use of personnel platform.*

(1) When using equipment to hoist employees, the employees must be in a personnel platform that meets the requirements of paragraph (e) of this section.

(2) *Exceptions:* A personnel platform is not required for hoisting employees:

- (i) Into and out of drill shafts that are up to and including 8 feet in diameter (see paragraph (o) of this section for requirements for hoisting these employees).
- (ii) In pile driving operations (see paragraph (p) of this section for requirements for hoisting these employees).
- (iii) Solely for transfer to or from a marine work-site in a marine-hoisted personnel transfer device (see paragraph (r) of this section for requirements for hoisting these employees).
- (iv) In storage-tank (steel or concrete), shaft and chimney operations (see paragraph (s) of this section for requirements for hoisting these employees).

(c) *Equipment set-up.*

- (1) The equipment must be uniformly level, within one percent of level grade, and located on footing that a qualified person has determined to be sufficiently firm and stable.
- (2) Equipment with outriggers or stabilizers must have them all extended and locked. The amount of extension must be the same for all outriggers and stabilizers and in accordance with manufacturer procedures and load charts.

(d) *Equipment criteria.*

- (1) *Capacity: Use of suspended personnel platforms.* The total load (with the platform loaded, including the hook, load line and rigging) must not exceed 50 percent of the rated capacity for the radius and configuration of the equipment, except during proof testing.
- (2) *Capacity: Use of boom-attached personnel platforms.* The total weight of the loaded personnel platform must not exceed 50 percent of the rated capacity for the radius and configuration of the equipment (except during proof testing).
- (3) *Capacity: Hoisting personnel without a personnel platform.* When hoisting personnel without a personnel platform pursuant to paragraph (b) (2) of this section, the total load (including the hook, load line, rigging and any other equipment that imposes a load) must not exceed 50 percent of the rated capacity for the radius and configuration of the equipment, except during proof testing.
- (4) When the occupied personnel platform is in a stationary working position, the load and boom hoist brakes, swing brakes, and operator actu-

ated secondary braking and locking features (such as pawls or dogs) or automatic secondary brakes must be engaged.

(5) *Devices.*

- (i) Equipment (except for derricks and articulating cranes) with a variable angle boom must be equipped with all of the following:
 - (A) A boom angle indicator, readily visible to the operator, and
 - (B) A boom hoist limiting device.
- (ii) Articulating cranes must be equipped with a properly functioning automatic overload protection device.
- (iii) Equipment with a luffing jib must be equipped with:
 - (A) A jib angle indicator, readily visible to the operator, and.
 - (B) A jib hoist limiting device.
- (iv) Equipment with telescoping booms must be equipped with a device to indicate the boom's extended length clearly to the operator, or must have measuring marks on the boom.
- (v) *Anti two-block.* A device which automatically prevents damage and load failure from contact between the load block, overhaul ball, or similar component, and the boom tip (or fixed upper block or similar component) must be used. The device(s) must prevent such damage/failure at all points where two-blocking could occur. Exception: This device is not required when hoisting personnel in pile driving operations. Instead, paragraph (p)(2) of this section specifies how to prevent two-blocking during such operations.
- (vi) *Controlled load lowering.* The load line hoist drum must have a system, other than the load line hoist brake, which regulates the lowering rate of speed of the hoist mechanism. This system or device must be used when hoisting personnel.

Note: Free fall of the load line hoist is prohibited (see § 1926.1426(d)); the use of equipment in which the boom hoist mechanism can free fall is also prohibited (see § 1926.1426(a)(1)).

- (vii) *Proper operation required.* Personnel hoisting operations must not begin unless the devices listed in this section are in proper working order. If a device stops working properly during such operations, the operator must safely stop operations. Personnel hoisting operations must not resume until the device is again working properly. Alternative measures are not permitted. (See § 1926.1417 for tag-out and related requirements.)

- (6) Direct attachment of a personnel platform to a luffing jib is prohibited.
- (e) *Personnel platform criteria.*
- (1) A qualified person familiar with structural design must design the personnel platform and attachment/ suspension system used for hoisting personnel.
 - (2) The system used to connect the personnel platform to the equipment must allow the platform to remain within 10 degrees of level, regardless of boom angle.
 - (3) The suspension system must be designed to minimize tipping of the platform due to movement of employees occupying the platform.
 - (4) The personnel platform itself (excluding the guardrail system and personal fall arrest system anchorages), must be capable of supporting, without failure, its own weight and at least five times the maximum intended load.
 - (5) All welding of the personnel platform and its components must be performed by a certified welder familiar with the weld grades, types and material specified in the platform design.
 - (6) The personnel platform must be equipped with a guardrail system which meets the requirements of subpart M of this part, and must be enclosed at least from the toeboard to mid-rail with either solid construction material or expanded metal having openings no greater than 1/2 inch (1.27 cm). Points to which personal fall arrest systems are attached must meet the anchorage requirements in subpart M of this part.
 - (7) A grab rail must be installed inside the entire perimeter of the personnel platform except for access gates/doors.
 - (8) *Access gates/doors.* If installed, access gates/doors of all types (including swinging, sliding, folding, or other types) must:
 - (i) Not swing outward. If due to the size of the personnel platform, such as a 1-person platform, it is infeasible for the door to swing inward and allow safe entry for the platform occupant, then the access gate/door may swing outward.
 - (ii) Be equipped with a device that prevents accidental opening.
 - (9) Headroom must be sufficient to allow employees to stand upright in the platform.
 - (10) In addition to the use of hard hats, employees must be protected by overhead protection on the personnel platform when employees are exposed to falling objects. The platform overhead protection must not obscure the view of the operator or platform occupants (such as wire mesh that has up to 1/2 inch openings), unless full protection is necessary.
- (11) All edges exposed to employee contact must be smooth enough to prevent injury.
- (12) The weight of the platform and its rated capacity must be conspicuously posted on the platform with a plate or other permanent marking.
- (f) *Personnel platform loading.*
- (1) The personnel platform must not be loaded in excess of its rated capacity.
 - (2) *Use.*
 - (i) Personnel platforms must be used only for employees, their tools, and the materials necessary to do their work. Platforms must not be used to hoist materials or tools when not hoisting personnel.
 - (ii) *Exception:* Materials and tools to be used during the lift, if secured and distributed in accordance with paragraph (f)(3) of this section may be in the platform for trial lifts.
 - (3) Materials and tools must be:
 - (i) Secured to prevent displacement.
 - (ii) Evenly distributed within the confines of the platform while it is suspended.
 - (4) The number of employees occupying the personnel platform must not exceed the maximum number the platform was designed to hold or the number required to perform the work, whichever is less.
- (g) *Attachment and rigging.*
- (1) *Hooks and other detachable devices.*
 - (i) Hooks used in the connection between the hoist line and the personnel platform (including hooks on overhaul ball assemblies, lower load blocks, bridle legs, or other attachment assemblies or components) must be:
 - (A) Of a type that can be closed and locked, eliminating the throat opening.
 - (B) Closed and locked when attached.
 - (ii) Shackles used in place of hooks must be of the alloy anchor type, with either:
 - (A) A bolt, nut and retaining pin, in place; or
 - (B) Of the screw type, with the screw pin secured from accidental removal.
 - (iii) Where other detachable devices are used, they must be of the type that can be closed and locked to the same extent as the devices addressed in paragraphs (g)(1)(i) and (ii) of this section. Such devices must be closed and locked when attached.
 - (2) *Rope bridle.* When a rope bridle is used to suspend the personnel platform, each bridle leg

must be connected to a master link or shackle (see paragraph (g)(1) of this section) in a manner that ensures that the load is evenly divided among the bridle legs.

- (3) Rigging hardware (including wire rope, shackles, rings, master links, and other rigging hardware) and hooks must be capable of supporting, without failure, at least five times the maximum intended load applied or transmitted to that component. Where rotation resistant rope is used, the slings must be capable of supporting without failure at least ten times the maximum intended load.
 - (4) Eyes in wire rope slings must be fabricated with thimbles.
 - (5) Bridles and associated rigging for suspending the personnel platform must be used only for the platform and the necessary employees, their tools and materials necessary to do their work. The bridles and associated rigging must not have been used for any purpose other than hoisting personnel.
- (h) *Trial lift and inspection.*
- (1) A trial lift with the unoccupied personnel platform loaded at least to the anticipated liftweight must be made from ground level, or any other location where employees will enter the platform, to each location at which the platform is to be hoisted and positioned. Where there is more than one location to be reached from a single set-up position, either individual trial lifts for each location, or a single trial lift, in which the platform is moved sequentially to each location, must be performed; the method selected must be the same as the method that will be used to hoist the personnel.
 - (2) The trial lift must be performed immediately prior to each shift in which personnel will be hoisted. In addition, the trial lift must be repeated prior to hoisting employees in each of the following circumstances:
 - (i) The equipment is moved and set up in a new location or returned to a previously used location.
 - (ii) The lift route is changed, unless the competent person determines that the new route presents no new factors affecting safety.
 - (3) The competent person must determine that:
 - (i) Safety devices and operational aids required by this section are activated and functioning properly. Other safety devices and operational aids must meet the requirements of § 1926.1415 and § 1926.1416.
 - (ii) Nothing interferes with the equipment or the personnel platform in the course of the trial lift.
 - (iii) The lift will not exceed 50 percent of the equipment's rated capacity at any time during the lift.
 - (iv) The load radius to be used during the lift has been accurately determined.
 - (4) Immediately after the trial lift, the competent person must:
 - (i) Conduct a visual inspection of the equipment, base support or ground, and personnel platform, to determine whether the trial lift has exposed any defect or problem or produced any adverse effect.
 - (ii) Confirm that, upon the completion of the trial lift process, the test weight has been removed.
 - (5) Immediately prior to each lift:
 - (i) The platform must be hoisted a few inches with the personnel and materials/tools on board and inspected by a competent person to ensure that it is secure and properly balanced.
 - (ii) The following conditions must be determined by a competent person to exist before the lift of personnel proceeds:
 - (A) Hoist ropes must be free of deficiencies in accordance with § 1926.1413(a).
 - (B) Multiple part lines must not be twisted around each other.
 - (C) The primary attachment must be centered over the platform.
 - (D) If the load rope is slack, the hoisting system must be inspected to ensure that all ropes are properly seated on drums and in sheaves.
 - (6) Any condition found during the trial lift and subsequent inspection(s) that fails to meet a requirement of this standard or otherwise creates a safety hazard must be corrected before hoisting personnel. (See § 1926.1417 for tag-out and related requirements.)
- (i) *[Reserved.]*
- (j) *Proof testing.*
- (1) At each jobsite, prior to hoisting employees on the personnel platform, and after any repair or modification, the platform and rigging must be proof tested to 125 percent of the platform's rated capacity. The proof test may be done concurrently with the trial lift.
 - (2) The platform must be lowered by controlled load lowering, braked, and held in a suspended position for a minimum of five minutes with the test load evenly distributed on the platform.

- (3) After proof testing, a competent person must inspect the platform and rigging to determine if the test has been passed. If any deficiencies are found that pose a safety hazard, the platform and rigging must not be used to hoist personnel unless the deficiencies are corrected, the test is repeated, and a competent person determines that the test has been passed. (*See* § 1926.1417 for tag-out and related requirements.)
- (4) Personnel hoisting must not be conducted until the competent person determines that the platform and rigging have successfully passed the proof test.
- (k) *Work practices.*
- (1) Hoisting of the personnel platform must be performed in a slow, controlled, cautious manner, with no sudden movements of the equipment or the platform.
- (2) Platform occupants must:
- (i) Keep all parts of the body inside the platform during raising, lowering, and horizontal movement. This provision does not apply to an occupant of the platform when necessary to position the platform or while performing the duties of a signal person.
- (ii) Not stand, sit on, or work from the top or intermediate rail or toeboard, or use any other means/device to raise their working height.
- (iii) Not pull the platform out of plumb in relation to the hoisting equipment.
- (3) Before employees exit or enter a hoisted personnel platform that is not landed, the platform must be secured to the structure where the work is to be performed, unless the employer can demonstrate that securing to the structure would create a greater hazard.
- (4) If the platform is tied to the structure, the operator must not move the platform until the operator receives confirmation that it is freely suspended.
- (5) Tag lines must be used when necessary to control the platform.
- (6) *Platforms without controls.* Where the platform is not equipped with controls, the equipment operator must remain at the equipment controls, on site, and in view of the equipment, at all times while the platform is occupied.
- (7) *Platforms with controls.* Where the platform is equipped with controls, all of the following must be met at all times while the platform is occupied:
- (i) The occupant using the controls in the platform must be a qualified person with respect to their use, including the safe limitations of the equipment and hazards associated with its operation.
- (ii) The equipment operator must be at a set of equipment controls that include boom and swing functions of the equipment, and must be on site and in view of the equipment.
- (iii) The platform operating manual must be in the platform or on the equipment.
- (8) *Environmental conditions.*
- (i) *Wind.* When wind speed (sustained or gusts) exceeds 20 mph at the personnel platform, a qualified person must determine if, in light of the wind conditions, it is not safe to lift personnel. If it is not, the lifting operation must not begin (or, if already in progress, must be terminated).
- (ii) *Other weather and environmental conditions.* A qualified person must determine if, in light of indications of dangerous weather conditions, or other impending or existing danger, it is not safe to lift personnel. If it is not, the lifting operation must not begin (or, if already in progress, must be terminated).
- (9) Employees being hoisted must remain in direct communication with the signal person (where used), or the operator.
- (10) *Fall protection.*
- (i) Except over water, employees occupying the personnel platform must be provided and use a personal fall arrest system. The system must be attached to a structural member within the personnel platform. When working over or near water, the requirements of § 1926.106 apply.
- (ii) The fall arrest system, including the attachment point (anchorage) used to comply with paragraph (i) of this section, must meet the requirements in § 1926.502.
- (11) *Other load lines.*
- (i) No lifts must be made on any other of the equipment's load lines while personnel are being hoisted, except in pile driving operations.
- (ii) *Factory-produced boom-mounted personnel platforms that incorporate a winch as original equipment.* Loads are permitted to be hoisted by such a winch while employees occupy the personnel platform only where the load on the winch line does not exceed 500 pounds and does not exceed the rated capacity of the winch and platform.
- (12) *Traveling—equipment other than derricks.*
- (i) Hoisting of employees while the equipment is traveling is prohibited, except for:
- (A) Equipment that travels on fixed rails; or

- (B) Where the employer demonstrates that there is no less hazardous way to perform the work.
- (C) This exception does not apply to rubber-tired equipment.
- (ii) Where employees are hoisted while the equipment is traveling, all of the following criteria must be met:
 - (A) Equipment travel must be restricted to a fixed track or runway.
 - (B) Where a runway is used, it must be a firm, level surface designed, prepared and designated as a path of travel for the weight and configuration of the equipment being used to lift and travel with the personnel platform. An existing surface may be used as long as it meets these criteria.
 - (C) Equipment travel must be limited to boom length.
 - (D) The boom must be parallel to the direction of travel, except where it is safer to do otherwise.
 - (E) A complete trial run must be performed to test the route of travel before employees are allowed to occupy the platform. This trial run can be performed at the same time as the trial lift required by paragraph (h) of this section which tests the lift route.
- (13) *Traveling—derricks.* Derricks are prohibited from traveling while personnel are hoisted.
- (l) *[Reserved.]*
- (m) *Pre-lift meeting.* A pre-lift meeting must be:
 - (1) Held to review the applicable requirements of this section and the procedures that will be followed.
 - (2) Attended by the equipment operator, signal person (if used for the lift), employees to be hoisted, and the person responsible for the task to be performed.
 - (3) Held prior to the trial lift at each new work location, and must be repeated for any employees newly assigned to the operation.
- (n) *Hoisting personnel near power lines.* Hoisting personnel within 20 feet of a power line that is up to 350 kV, and hoisting personnel within 50 feet of a power line that is over 350 kV, is prohibited, except for work covered by subpart V of this part (Power Transmission and Distribution).
- (o) *Hoisting personnel in drill shafts.* When hoisting employees into and out of drill shafts that are up to and including 8 feet in diameter, all of the following requirements must be met:
 - (1) The employee must be in either a personnel platform or on a boatswain's chair.
 - (2) If using a personnel platform, paragraphs (a) through (n) of this section apply.
 - (3) If using a boatswain's chair:
 - (i) The following paragraphs of this section apply: (a), (c), (d)(1), (d)(3), (d)(4), (e)(1), (e)(2), (e)(3), (f)(1), (f)(2)(i), (f)(3)(i), (g), (h), (k)(1), (k)(6), (k)(8), (k)(9), (k)(11)(i), (m), (n). Where the terms "personnel platform" or "platform" are used in these paragraphs, substitute them with "boatswain's chair."
 - (ii) A signal person must be stationed at the shaft opening.
 - (iii) The employee must be hoisted in a slow, controlled descent and ascent.
 - (iv) The employee must use personal fall protection equipment, including a full body harness, attached independent of the crane/derrick.
 - (v) The fall protection equipment must meet the applicable requirements in § 1926.502.
 - (vi) The boatswain's chair itself (excluding the personal fall arrest system anchorages), must be capable of supporting, without failure, its own weight and at least five times the maximum intended load.
 - (vii) No more than one person must be hoisted at a time.
 - (p) *Hoisting personnel for pile driving operations.* When hoisting an employee in pile driving operations, the following requirements must be met:
 - (1) The employee must be in a personnel platform or boatswain's chair.
 - (2) *For lattice boom cranes:* Clearly mark the cable (so that it can easily be seen by the operator) at a point that will give the operator sufficient time to stop the hoist to prevent two-blocking, or use a spotter who is in direct communication with the operator to inform the operator when this point is reached.
For telescopic boom cranes: Clearly mark the cable (so that it can be easily seen by the operator) at a point that will give the operator sufficient time to stop the hoist to prevent two-blocking, and use a spotter who is in direct communication with the operator to inform the operator when this point is reached.
 - (3) If using a personnel platform, paragraphs (b) through (n) of this section apply.
 - (4) If using a boatswain's chair:
 - (i) The following paragraphs of this section apply: (a), (c), (d)(1), (d)(3), (d)(4), (e)(1), (e)(2), (e)(3), (f)(1), (f)(2)(i), (f)(3)(i), (g), (h), (j), (k)(1), (k)(6), (k)(8), (k)(9), (k)(11)(i),

(m), and (n). Where the terms “personnel platform” or “platform” are used in these paragraphs, substitute them with “boatswains chair.”

- (ii) The employee must be hoisted in a slow, controlled descent and ascent.
- (iii) The employee must use personal fall protection equipment, including a full body harness, independently attached to the lower load block or overhaul ball.
- (iv) The fall protection equipment must meet the applicable requirements in § 1926.502.
- (v) The boatswain’s chair itself (excluding the personal fall arrest system anchorages), must be capable of supporting, without failure, its own weight and at least five times the maximum intended load.
- (vi) No more than one person must be hoisted at a time.

(q) *[Reserved.]*

(r) *Hoisting personnel for marine transfer.* When hoisting employees solely for transfer to or from a marine worksite, the following requirements must be met:

- (1) The employee must be in either a personnel platform or a marine-hoisted personnel transfer device.
- (2) If using a personnel platform, paragraphs (a) through (n) of this section apply.
- (3) If using a marine-hoisted personnel transfer device:
 - (i) The following paragraphs of this section apply: (a), (c)(2), (d)(1), (d)(3), (d)(4), (e)(1) through (5), (e)(12), (f)(1), (g), (h), (j), (k)(1), (k)(8), (k)(9), (k)(10)(ii), (k)(11)(i), (k)(12), (m), and (n). Where the terms “personnel platform” or “platform” are used in these paragraphs, substitute them with “marine-hoisted personnel transfer device.”
 - (ii) The transfer device must be used only for transferring workers.
 - (iii) The number of workers occupying the transfer device must not exceed the maximum number it was designed to hold.
 - (iv) Each employee must wear a U.S. Coast Guard personal flotation device approved for industrial use.

(s) *Hoisting personnel for storage-tank (steel or concrete), shaft and chimney operations.* When hoisting an employee in storage tank (steel or concrete), shaft and chimney operations, the following requirements must be met:

- (1) The employee must be in a personnel platform except when the employer can demonstrate that use of a personnel platform is infeasible; in such a case, a boatswain’s chair must be used.

(2) If using a personnel platform, paragraphs (a) through (n) of this section apply.

(3) If using a boatswain’s chair:

(i) The following paragraphs of this section apply: (a), (c), (d)(1), (d)(3), (d)(4), (e)(1), (e)(2), (e)(3), (f)(1), (f)(2)(i), (f)(3)(i), (g), (h), (k)(1), (k)(6), (k)(8), (k)(9), (k)(11)(i), (m), (n). Where the terms “personnel platform” or “platform” are used in these paragraphs, substitute them with “boatswains chair.”

- (ii) The employee must be hoisted in a slow, controlled descent and ascent.
- (iii) The employee must use personal fall protection equipment, including a full body harness, attached independent of the crane/derrick. When there is no adequate structure for attachment of personal fall arrest equipment as required in § 1926.502(d)(15), the attachment must be to the lower load block or overhaul ball.
- (iv) The fall protection equipment must meet the applicable requirements in § 1926.502.
- (v) The boatswain’s chair itself (excluding the personal fall arrest system anchorages), must be capable of supporting, without failure, its own weight and at least five times the maximum intended load.
- (vi) No more than one person must be hoisted at a time.

§ 1926.1432 Multiple-crane/derrick lifts—supplemental requirements







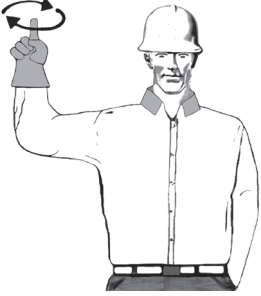

(a) *Plan development.* Before beginning a crane/derrick operation in which more than one crane/derrick will be supporting the load, the operation must be planned. The planning must meet the following requirements:

- (1) The plan must be developed by a qualified person.
- (2) The plan must be designed to ensure that the requirements of this subpart are met.
- (3) Where the qualified person determines that engineering expertise is needed for the planning, the employer must ensure that it is provided.

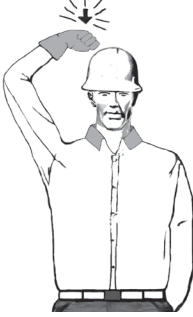
(b) *Plan implementation.*

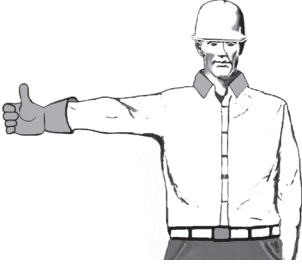
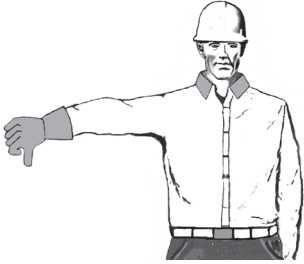
- (1) The multiple-crane/derrick lift must be directed by a person who meets the criteria for both a competent person and a qualified person, or by a competent person who is assisted by one or more qualified persons (lift director).
- (2) The lift director must review the plan in a meeting with all workers who will be involved with the operation.

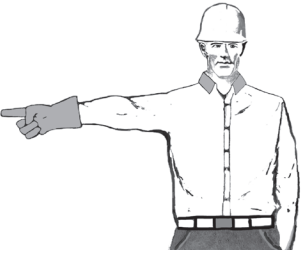
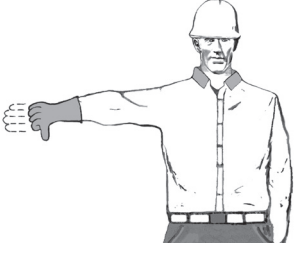
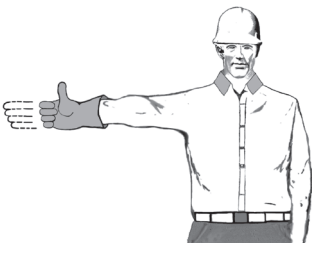
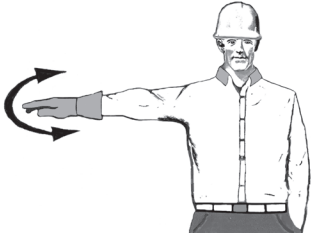
Appendix A to Subpart CC of Part 1926—Standard Hand Signals

 <p>HOIST With upper arm extended to the side, forearm and index finger pointing straight up, hand and finger make small circles.</p>	 <p>LOWER With arm and index finger pointing down, hand and finger make small circles.</p>	 <p>USE MAIN HOIST A hand taps on top of the head. Then regular signal is given to indicate desired action.</p>	 <p>USE AUXILIARY HOIST (Whipline) With arm bent at elbow and forearm vertical, elbow is tapped with other hand. Then regular signal is used to indicate desired action.</p>
 <p>BOOM UP With arm extended horizontally to the side, thumb points up with other fingers closed.</p>	 <p>BOOM DOWN With arm extended horizontally to the side, thumb points down with other fingers closed.</p>	 <p>MOVE SLOWLY A hand is placed in front of the hand that is giving the action signal. (Hoist slowly shown in example.)</p>	 <p>SWING With arm extended horizontally, index finger points in direction that boom is to swing.</p>
 <p>BOOM DOWN & RAISE THE LOAD With arm extended horizontally to the side and thumb pointing down, fingers open and close while load movement is desired.</p>	 <p>BOOM UP & LOWER THE LOAD With arm extended horizontally to the side and thumb pointing up, fingers open and close while load movement is desired.</p>	 <p>STOP With arm extended horizontally to the side, palm down, arm is swung back and forth.</p>	 <p>DOG EVERYTHING Hands held together at waist level.</p>

© 2013 National Commission for the Certification of Crane Operators. All rights reserved.



TRAVEL/TOWER TRAVEL

With all fingers pointing up, arm is extended horizontally out and back to make a pushing motion in the direction of travel.

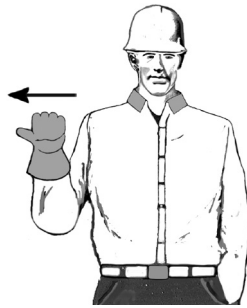

TROLLEY TRAVEL

With palm up, fingers closed, and thumb pointing in direction of motion, hand is jerked in direction trolley is to travel.



CRAWLER CRANE TRAVEL, BOTH TRACKS

Rotate fists around each other in front of body; direction of rotation towards body indicates travel forward; rotation away from body indicates travel backward.



CRAWLER CRANE TRAVEL, ONE TRACK

Indicate track to be locked by raising fist on that side. Rotate other fist in front of body in direction that other track is to travel.



TELESCOPE OUT

With hands to the front at waist level, thumbs point outward with other fingers closed.

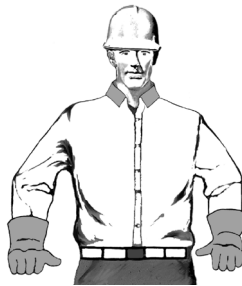

TELESCOPE IN

With hands to the front at waist level, thumbs point at each other with other fingers closed.



TELESCOPE OUT (One-handed signal)

One fist in front of chest with thumb tapping chest.



TELESCOPE IN (One-handed signal)

One fist in front of chest, thumb pointing outward and heel of fist tapping chest.

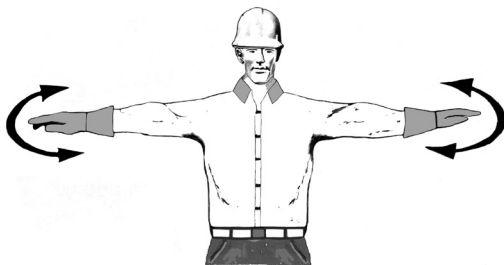

EMERGENCY STOP

With both arms extended horizontally to the side, palms down, arms are swung back and forth.

Hand signal descriptions compiled from OSHA and ASME B30 standards.



CHAPTER 7:
Rigger Reference Booklet

RIGGER REFERENCE BOOKLET

This Reference Booklet has been produced and adapted from various manufacturers' data and is for use in NCCCO written examinations.

This Reference Booklet is not to be used for any other purpose.

Copyright 2009–2019 National Commission for the Certification of Crane Operators (NCCCO). All rights reserved. This document may not be reproduced in whole or in part without the express written permission of the manufacturer and the consent of NCCCO.

HOLD HARMLESS/RELEASE/DISCLAIMER AGREEMENT

The reading and/or using person or entities using this publication for and in consideration of the assistance, cooperation, and information given by the National Commission for the Certification of Crane Operators (NCCCO) in this publication, *Rigger Reference Booklet*, the receipt of which is acknowledged, does hereby and for all future time have released, hold harmless from any liability, and forever discharged for itself, its administrators and assigns the said NCCCO from all and any manner of action or demands whatsoever in law, in admiralty, or in equity, which against the said NCCCO anyone ever had, now have, or which shall be later claimed. This agreement relates specifically to any cause of action arising out of the publication, information provided, subsequent conduct, and any use of the information provided in this publication and related uses or demonstrations of skills, methods, and techniques cited in the publication. This mutually

beneficial release and hold harmless agreement may not be changed orally and exists in perpetuity. NCCCO generally and specifically disclaims any warranty, merchantability of intended or unintended use, or liability for use of the in the information. This publication is issued solely as a public service to improve the lifting industry and promote public safety.

Copyright 2009–2019 by National Commission for the Certification of Crane Operators. All rights reserved. No part of this book may be reproduced or transmitted in any form or by any means, electronic or mechanical, including photocopying, recording, or by any information storage and retrieval system, without prior written permission from the publisher. For information, contact the publisher, National Commission for the Certification of Crane Operators.

General Data

1

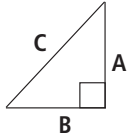
$A^2 + B^2 = C^2$ $C^2 - A^2 = B^2$ $C^2 - B^2 = A^2$ Area of a triangle = $\frac{1}{2} \times A \times B$		<ul style="list-style-type: none"> • d = diameter • L = length • W = width • Circumference = $\pi \times d$ • Volume of rectangular prism = $L \times W \times H$ 	<ul style="list-style-type: none"> • r = radius • H = height • π or Pi = 3.14 • Area of a circle = $\pi \times r^2$ • Area of a square = $L \times W$
Wire Rope Sling D/d Ratio Strength Efficiencies 25:1 = 1.00 20:1 = .92 15:1 = .88 10:1 = .86 4:1 = .75 2:1 = .65 1:1 = .50	1 yard = 3 ft. = 36 in. = .91 meter 1 meter = 1.09 yd. = 3.28 ft. = 39.37 in. 1 ton (short) = .891 long ton = .91 metric ton = 2,000 lbs. = 907 kg 1 ton (metric) = 1.1 short ton = .98 long ton = 2,204 lb. = 1,000 kg 1 pound = .45 kg 1 kg = 1,000 grams = 2.2 lb. 1 gallon (U.S. liq.) = 4 qt. = 3.8 liters 1 liter = .264 gallon (U.S.) = 1.06 qt. 1 KIP = 1,000 lb.		

Calculating Load Weights

2

Materials and Liquids - Pounds / cu. ft.		Pounds / sq. ft.		Pounds / gallon	
Aluminum	168	Iron Casting	460	Steel plate	
Asbestos	153	Lead	710	• 1/8 inch	5
Asphalt	80	Lumber—Fir	40	• 1/4 inch	10
Brass	521	Lumber—Oak	62	• 1/2 inch	20
Brick	120	Lumber—Railroad Ties	50	• 1 inch	40
Bronze	500	Oil, Motor	58	Aluminum plate	
Coal	56	Paper	60	• 1/8 inch	1.75
Concrete, Reinforced	150	Portland Cement	94	• 1/4 inch	3.50
Crushed Rock	95	River Sand	120	Lumber	
Diesel	53	Rubber	94	• 3/4 inch Fir	2.5
Dry Earth, Loose	74	Steel	480	• 3/4 inch Oak	4.0
Gasoline	45	Water	62		
Glass	160	Zinc	437		

7.5 gallons of liquid to a cubic foot
27 cubic feet to a cubic yard

Load Factors & Weight Distribution

3

$$\text{Sling Tension} = \frac{\text{Sling Length (L)}}{\text{Sling Height (H)}} \times \text{share of load wt.}$$

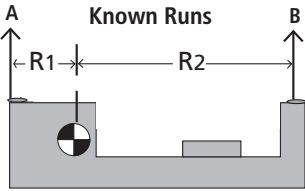
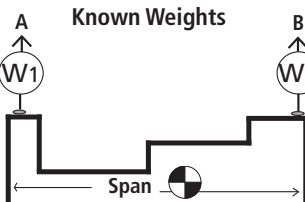
	<table border="1"> <thead> <tr> <th>Share of Load Wt. @ A</th> <th>Share of Load Wt. @ B</th> <th>Legend</th> </tr> </thead> <tbody> <tr> <td>$R_1 + R_2 = TS$</td> <td>$R_1 + R_2 = TS$</td> <td>$R_1 = \text{Run, Side 1}$</td> </tr> <tr> <td>$\frac{R_2}{TS} = P$</td> <td>$\frac{R_1}{TS} = P$</td> <td>$R_2 = \text{Run, Side 2}$</td> </tr> <tr> <td>$P \times W = \text{Share of Load Wt. @ A}$</td> <td>$P \times W = \text{Share of Load Wt. @ B}$</td> <td>$TS = \text{Total Span}$</td> </tr> <tr> <td></td> <td></td> <td>$P = \text{Percentage}$</td> </tr> <tr> <td></td> <td></td> <td>$W = \text{Weight of Load}$</td> </tr> </tbody> </table>	Share of Load Wt. @ A	Share of Load Wt. @ B	Legend	$R_1 + R_2 = TS$	$R_1 + R_2 = TS$	$R_1 = \text{Run, Side 1}$	$\frac{R_2}{TS} = P$	$\frac{R_1}{TS} = P$	$R_2 = \text{Run, Side 2}$	$P \times W = \text{Share of Load Wt. @ A}$	$P \times W = \text{Share of Load Wt. @ B}$	$TS = \text{Total Span}$			$P = \text{Percentage}$			$W = \text{Weight of Load}$
Share of Load Wt. @ A	Share of Load Wt. @ B	Legend																	
$R_1 + R_2 = TS$	$R_1 + R_2 = TS$	$R_1 = \text{Run, Side 1}$																	
$\frac{R_2}{TS} = P$	$\frac{R_1}{TS} = P$	$R_2 = \text{Run, Side 2}$																	
$P \times W = \text{Share of Load Wt. @ A}$	$P \times W = \text{Share of Load Wt. @ B}$	$TS = \text{Total Span}$																	
		$P = \text{Percentage}$																	
		$W = \text{Weight of Load}$																	
	<table border="1"> <thead> <tr> <th>CG In Feet From A</th> <th>CG In Feet From B</th> <th>Legend</th> </tr> </thead> <tbody> <tr> <td>$W_1 + W_2 = TW$</td> <td>$W_1 + W_2 = TW$</td> <td>$W_1 = \text{Weight at A}$</td> </tr> <tr> <td>$\frac{W_2}{TW} = P$</td> <td>$\frac{W_1}{TW} = P$</td> <td>$W_2 = \text{Weight at B}$</td> </tr> <tr> <td>$P \times S = \text{CG in ft. from A}$</td> <td>$P \times S = \text{CG in ft. from B}$</td> <td>$TW = \text{Total Weight}$</td> </tr> <tr> <td></td> <td></td> <td>$P = \text{Percentage}$</td> </tr> <tr> <td></td> <td></td> <td>$S = \text{Span}$</td> </tr> </tbody> </table>	CG In Feet From A	CG In Feet From B	Legend	$W_1 + W_2 = TW$	$W_1 + W_2 = TW$	$W_1 = \text{Weight at A}$	$\frac{W_2}{TW} = P$	$\frac{W_1}{TW} = P$	$W_2 = \text{Weight at B}$	$P \times S = \text{CG in ft. from A}$	$P \times S = \text{CG in ft. from B}$	$TW = \text{Total Weight}$			$P = \text{Percentage}$			$S = \text{Span}$
CG In Feet From A	CG In Feet From B	Legend																	
$W_1 + W_2 = TW$	$W_1 + W_2 = TW$	$W_1 = \text{Weight at A}$																	
$\frac{W_2}{TW} = P$	$\frac{W_1}{TW} = P$	$W_2 = \text{Weight at B}$																	
$P \times S = \text{CG in ft. from A}$	$P \times S = \text{CG in ft. from B}$	$TW = \text{Total Weight}$																	
		$P = \text{Percentage}$																	
		$S = \text{Span}$																	

Level & Incline Planes

4

Legend	Formulas
W = Weight of load	Level: $F = CF \times W$
CF = Coefficient of Friction	
F = Force required to move load	Uphill: $F = (CF \times R/L \times W) + (W \times H/L)$
H = Height in feet	
R = Run, horizontal distance in feet	Downhill: $F = (CF \times R/L \times W) - (W \times H/L)$
L = Length of ramp in feet	

Coefficients of Friction [For Estimation Only]

Concrete on concrete	.65	Wood on metal	.30	Steel on steel	.10
Metal on concrete	.60	Cast iron on steel	.25	Load on wheels	.05
Wood on wood	.50	Continuous lubricated surface	.15	Load on ice	.01
Wood on concrete	.45			Load on air	.002

Level Pick Points

5

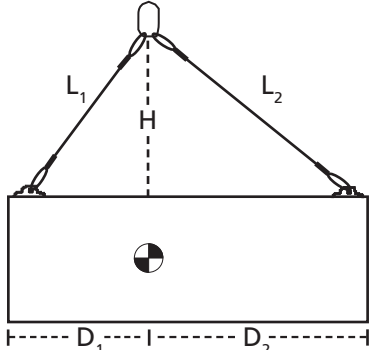
Legend	
W = Load Weight	
D ₁ = Distance of Side 1	
D ₂ = Distance of Side 2	
L ₁ = Sling Length, Side 1	
L ₂ = Sling Length, Side 2	
H = Vertical Height	
TL ₁ = Tension, Length 1	
TL ₂ = Tension, Length 2	

$$TL_1 = \frac{L_1 \times W \times D_2}{H \times (D_1 + D_2)}$$

$$TL_2 = \frac{L_2 \times W \times D_1}{H \times (D_1 + D_2)}$$

Off-level Pick Points

6

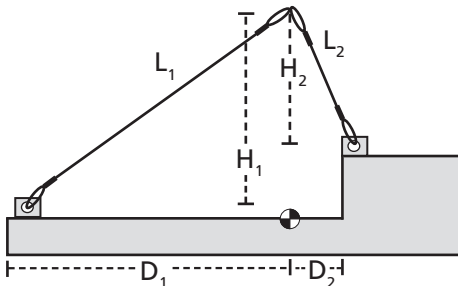
Legend	
W = Load Weight	
D ₁ = Distance of Side 1	
D ₂ = Distance of Side 2	
L ₁ = Sling Length, Side 1	
L ₂ = Sling Length, Side 2	
H ₁ = Vertical Height, Side 1	
H ₂ = Vertical Height, Side 2	
TL ₁ = Tension, Length 1	
TL ₂ = Tension, Length 2	

$$TL_1 = \frac{W \times D_2 \times L_1}{(D_2 \times H_1) + (D_1 \times H_2)}$$

$$TL_2 = \frac{W \times D_1 \times L_2}{(D_2 \times H_1) + (D_1 \times H_2)}$$

Block & Fairlead Loading

7

Full Included Angle	Block Factor
180	0.00
170	0.17
160	0.35
150	0.52
140	0.68
130	0.84
120	1.00
110	1.15
100	1.29
90	1.41
80	1.53
70	1.64
60	1.73
50	1.81
40	1.87
30	1.93
20	1.97
10	1.99
0	2.00

Example

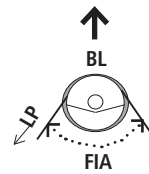

BL = Block Load
 BF = Block Factor
 LP = Line Pull
 FIA = Full Included Angle

Formula
 BL = BF × LP

Wire Rope EIPS/IWRC Sling Capacities (lb.)



Mechanical Splice

8

Size in inches						
1/4	1,300	960	2,600	2,200	1,820	1,300
5/16	2,000	1,480	4,000	3,400	2,800	2,000
3/8	2,800	2,200	5,600	5,000	4,000	2,800
7/16	3,800	2,800	7,600	6,800	5,400	3,800
1/2	5,000	3,800	10,000	8,800	7,200	5,000
9/16	6,400	4,800	12,800	11,000	9,000	6,400
5/8	7,800	5,800	15,600	13,600	11,000	7,800
3/4	11,200	8,200	22,400	19,400	15,800	11,200
7/8	15,200	11,200	30,400	26,000	22,000	15,200
1	19,600	14,400	39,200	34,000	28,000	19,600
1-1/8	24,000	18,000	48,000	42,000	34,000	24,000
1-1/4	30,000	22,500	60,000	52,000	42,000	30,000

3-Part Braided Wire Rope Sling Capacities (tons)



9

Finished Diameter (inches)	Composed of 3 parts of EIP Rope (inches)				Weight Per Ft. Approx. (pounds)
1/2	1/4	1.7	1.3	3.4	.44
5/8	5/16	2.6	1.9	5.2	.68
3/4	3/8	3.6	2.7	7.2	.99
7/8	7/16	4.9	3.7	9.8	1.33
1	1/2	6.4	4.8	12.8	1.75
1-1/8	9/16	8.0	6.0	16.0	2.24
1-3/4	7/8	19.0	14.3	36.0	5.40
2-1/4	1-1/8	31.2	23.4	62.4	8.90
2-3/4	1-3/8	46.0	34.5	92.0	13.30
3-1/4	1-5/8	63.4	47.6	126.8	18.50
4	2	95.0	71.2	190.0	28.00
4-1/2	2-1/4	118.0	88.5	236.0	35.60
5	2-1/2	145.0	109.0	290.0	44.00

Basket-rated capacities based on D/d ratio of five times the wire rope's finished diameter.

9-Part Braided Wire Rope Sling Capacities (tons)







10

Finished Diameter (inches)	Composed of 9 parts of EIP Rope (inches)			
1/2	1/8	1.4	1.0	2.8
5/8	5/32	2.0	1.5	4.0
3/4	3/16	3.0	2.2	6.0
7/8	7/32	4.0	3.0	8.0
1	1/4	4.8	3.6	9.6
1-1/2	3/8	10.5	7.8	21.0
2	1/2	19.1	14.3	38.2
2-1/2	5/8	29.6	22.2	59.2
3	3/4	42.3	31.7	84.6
3-1/2	7/8	57.3	42.9	114.6
4	1	74.4	55.8	148.4
4-1/2	1-1/8	93.6	60.2	187.2

Basket-rated capacities based on D/d ratio of five times the wire rope's finished diameter.

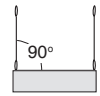



Synthetic Sling Capacities (lb.)

11

	Size or Code						
Web Eye / Eye	1-9-1	1,600	1,280	3,200	2,770	2,260	1,600
	1-9-2	3,200	2,560	6,400	5,540	4,452	3,200
	1-9-3	4,800	3,840	9,600	8,320	6,780	4,800
	1-9-4	6,400	5,120	12,800	11,090	9,040	6,400
	2-9-3	8,880	7,100	17,760	15,390	12,540	8,880
	2-9-4	11,520	9,210	23,040	19,960	16,270	11,520
Polyester Round	1	2,600	2,100	5,200	4,500	3,600	2,600
	2	5,300	4,200	10,600	9,100	7,500	5,300
	3	8,400	6,700	16,800	14,500	11,800	8,400
	4	10,600	8,500	21,200	18,300	14,900	10,600
	5	13,200	10,600	26,400	22,800	18,600	13,200
	6	16,800	13,400	33,600	29,100	23,700	16,800

High Capacity Round Sling Capacities (lb.)*

12



Dual-Path Model						Approx. Body Width (inches)
DP 1000	10,000	8,000	20,000	17,320	14,140	3
DP 1500	15,000	12,000	30,000	25,980	21,210	3
DP 2000	20,000	16,000	40,000	34,640	28,280	3
DP 2500	25,000	20,000	50,000	43,300	35,350	3
DP 3000	30,000	24,000	60,000	51,960	42,420	4
DP 4000	40,000	32,000	80,000	69,280	56,560	4
DP 5000	50,000	40,000	100,000	86,600	70,700	5
DP 6000	60,000	48,000	120,000	103,920	84,840	5
DP 7000	70,000	56,000	140,000	121,240	98,980	5
DP 8500	85,000	68,000	170,000	147,220	120,190	6
DP 10000	100,000	80,000	200,000	173,200	141,400	6
DP 12500	125,000	100,000	250,000	216,500	176,750	8
DP 15000	150,000	120,000	300,000	259,800	212,100	8
DP 17500	175,000	140,000	350,000	303,100	247,450	10
DP 20000	200,000	160,000	400,000	346,400	282,800	10
DP 25000	250,000	200,000	500,000	433,000	353,500	10
DP 27500	275,000	220,000	550,000	476,300	388,850	12
DP 30000	300,000	240,000	600,000	519,600	424,200	12
DP 40000	400,000	320,000	800,000	692,800	565,600	14
DP 50000	500,000	400,000	1,000,000	866,000	707,000	16

*Capacities shown include both paths and are for one complete sling; sling ratings based on fittings of equal or greater capacity.

Alloy Chain Sling Capacities (lb.)

13

Grade 80

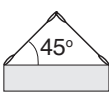
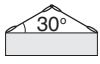
Size in inches	Single Leg		Two Leg Slings			Three & Four Leg Slings	
						60°	45°
9/32	3,500	2,800	6,100	4,900	3,500	9,150	7,400
3/8	7,100	5,700	12,300	10,000	7,100	18,400	15,100
1/2	12,000	9,600	20,800	17,000	12,000	31,200	25,500
5/8	18,100	14,500	31,300	25,600	18,100	47,000	38,400
3/4	28,300	22,600	49,000	40,000	28,300	73,500	60,000
7/8	34,200	27,400	59,200	48,400	34,200	88,900	72,500
1	47,700	38,200	82,600	67,400	47,700	123,900	101,200
1-1/4	72,300	57,800	125,200	102,200	72,300	187,800	153,400

Grade 100

9/32	4,300	3,500	7,400	6,100	4,300	11,200	9,100
3/8	8,800	7,100	15,200	12,400	8,800	22,900	18,700
1/2	15,000	12,000	26,000	21,200	15,000	39,000	31,800
5/8	22,600	18,100	39,100	32,000	22,600	58,700	47,900
3/4	35,300	28,300	61,100	49,900	35,300	91,700	74,900
7/8	42,700	34,200	74,000	60,400	42,700	110,900	90,600

Rigging Hardware Capacities (lb.)

14

Size in inches	Shoulder Eye Bolt		Turnbuckle Eye or Jaw	Shackle SP Anchor	Wire Rope Clip			Swivel Hoist Rings WLL (lbs.)	Alloy Master Links WLL (lbs.)
	In Line	45 deg.			Min. # clips	Turnback (inches)	Torque (ft. lbs.)		
1/4	500	125	500	1,000	2	4.75	15	-----	-----
5/16	800	200	800	1,500	2	5.25	30	800	-----
3/8	1,200	300	1,200	2,000	2	6.50	45	1,000	-----
7/16	-----	-----	-----	3,000	2	7.00	65	-----	-----
1/2	2,200	550	2,200	4,000	3	11.50	65	2,500	7,400
9/16	-----	-----	-----	-----	3	12.00	95	-----	-----
5/8	3,500	875	3,500	6,500	3	12.00	95	4,000	9,000
3/4	5,200	1,300	5,200	9,500	4	18.00	130	5,000	12,300
7/8	7,200	1,800	7,200	13,000	4	19.00	225	8,000	15,200
1	10,000	2,500	10,000	17,000	5	26.00	225	10,000	26,000
1-1/8	-----	-----	-----	19,000	6	34.00	225	-----	-----
1-1/4	15,200	3,800	15,200	24,000	7	44.00	360	15,000	39,100
1-1/2	-----	-----	-----	-----	-----	-----	-----	-----	61,100
2	-----	-----	-----	-----	-----	-----	-----	-----	102,600
2-1/2	-----	-----	-----	-----	-----	-----	-----	-----	160,000
3	-----	-----	-----	-----	-----	-----	-----	-----	228,000
3-1/2	-----	-----	-----	-----	-----	-----	-----	-----	279,000
4	-----	-----	-----	-----	-----	-----	-----	-----	373,000

Synthetic Sling Shackle

15

Round Sling Size (No.)	Web Slings*		Working Load Limit (Tons)
	Webbing Width (in.)	Eye Width (in.)	
1	2	2	3-1/4
2	2	2	3-1/4
3	3	1.5	4-1/2
4	4	2	6-1/4
5	6	3	8-1/2
6	6	3	8-1/2

* NOTE: Designed for use with Type III, (Eye & Eye), Class 7, 2 Ply web slings. For 3" and larger webbing width, tapered eye is required.

Wide Body Shackles

16

Working Load Limit (Tons)	Weight Each (lbs.)	Dimensions in Inches			"B" is spread between shackle ears "D" is shackle pin diameter Effective Body Diameter is the diameter to use when calculating D/d ratio for sling: D = effective body diameter d = sling diameter
		B +/- .02	D +/- .02	Effective Body Diameter	
7	4.0	1.25	0.88	2.1	
12.5	8.8	1.69	1.13	2.4	
18	14.9	2.03	1.38	2.8	
30	26.5	2.37	1.63	4.1	
40	35.0	2.88	2.00	3.6	
55	68.0	3.25	2.25	4.3	
75	99.0	4.13	2.75	5.9	
125	161	5.12	3.15	6.8	
200	370	5.91	4.12	8.9	
300	847	7.38	5.25	11.8	
400	1130	8.66	6.30	14.3	

This page intentionally left blank

IMPORTANT CONTACT INFORMATION



NATIONAL COMMISSION FOR THE CERTIFICATION OF CRANE OPERATORS

2750 Prosperity Avenue, Suite 505
Fairfax, VA 22031-4312

Phone: 703-560-2391

Fax: 703-560-2392

Email: info@nccco.org



**NATIONAL COMMISSION FOR THE
CERTIFICATION OF CRANE OPERATORS**

2750 Prosperity Avenue, Suite 505
Fairfax, VA 22031-4312

Phone: 703-560-2391

Fax: 703-560-2392

info@nccco.org

www.nccco.org